

Beej's Guide to Git

Brian "Beej Jorgensen" Hall

v1.2.0, Copyright © February 11, 2025

Contents

1	Foreword	1
1.1	Audience	1
1.2	Official Homepage	2
1.3	Email Policy	2
1.4	Mirroring	2
1.5	Note for Translators	2
1.6	Copyright and Distribution	2
1.7	Dedication	3
2	Git Basics	4
2.1	What is Git?	4
2.1.1	Definitions	4
2.2	What is GitHub?	5
2.3	What is GitHub?	5
2.4	The Most Basic Git Workflow	5
2.4.1	Definitions	6
2.5	What is Cloning?	6
2.5.1	Definitions	6
2.6	How Do Clones Interact?	6
2.7	Actual Git Usage	7
2.7.1	Step 0: One-time Setup	7
2.7.2	Step 1: Clone an Existing Repo	8
2.7.3	Step 2: Make Some Local Changes	9
2.7.4	Step 3: Add Changes to the Stage	11
2.7.5	Step 4: Commit those Changes	12
2.7.6	Step 5: Push Your Changes to the Remote Repo	13
3	GitHub: How To Use It	14
3.1	Making a GitHub Account	14
3.2	Creating a New Repo on GitHub	14
3.3	Authentication	15
3.3.1	GitHub CLI	15
3.3.2	SSH Keys	16
3.3.3	Using Personal Access Tokens	17
3.4	Make a Local Clone of the Repo	18
3.4.1	Cloning from GitHub with GitHub CLI	18
3.4.2	Cloning from GitHub with SSH Keys	19
3.5	Make Changes and Push!	19
3.6	Collaboration on GitHub	19
4	The Git Log and HEAD	21
4.1	An Example Log	21
4.2	What's in the log?	22
4.3	The HEAD Reference	22

4.4	Going Back In Time and Detached HEAD	23
4.5	The Old Command: <code>git checkout</code>	25
4.6	Commits Relative to HEAD	26
5	Branches and Fast-Forward Merges	27
5.1	What is a Branch?	27
5.2	A Quick Note about <code>git pull</code>	29
5.3	HEAD and Branches	29
5.4	Listing All Your Branches	30
5.5	Creating a Branch	31
5.6	Make Some Commits on a Branch	32
5.7	Merging: Fast-Forward	33
5.8	Deleting a Branch	35
6	Merging and Conflicts	36
6.1	An Example of Divergent Branches	36
6.2	Merging Divergent Branches	37
6.3	Merge Conflicts	38
6.4	What a Conflict Looks Like	38
6.5	Why Merge Conflicts Happen	41
6.6	Merging with IDEs or other Merge Tools	41
6.7	Merge Big Ideas	41
7	Using Subdirectories with Git	42
7.1	Repos and Subdirectories	42
7.1.1	What about Subprojects?	42
7.2	Accidentally Making a Repo in your Home Directory	42
7.3	Empty Subdirectories in Repos	43
8	Ignoring Files with <code>.gitignore</code>	44
8.1	Adding a <code>.gitignore</code> File	44
8.2	Can I Specify Subdirectories in <code>.gitignore</code> ?	45
8.3	Where do I Put the <code>.gitignore</code> ?	46
8.4	Wildcards	46
8.5	Negated <code>.gitignore</code> Rules	46
8.6	How To Ignore All Files Except a Few?	47
8.7	Getting Premade <code>.gitignore</code> Files	47
9	Remotes: Repos in Other Places	48
9.1	Remote and Branch Notation	48
9.2	Getting a List of Remotes	48
9.3	Changing a Remote's URL	49
9.4	Adding a Remote	49
10	Remote Tracking Branches	51
10.1	Branches on Remotes	51
10.2	Listing Remote Tracking Branches	52
10.3	Pushing to a Remote	53
10.4	Making a Branch and Pushing to Remote	53
10.5	Deleting Remote Tracking Branches	55
10.5.1	Fetching Deleted Remote Branches	55
10.5.2	Deleting Your Remote Tracking Branch	55
10.5.3	Deleting a Branch on a Remote	55
10.6	Multiple Remotes	56

11 File States	58
11.1 What States Can Files in Git Be In?	58
11.2 Unmodified to Untracked	59
11.3 Files In Multiple States	60
12 Comparing Files with Diff	61
12.1 Basic Usage	61
12.2 Diffing the Stage	62
12.3 More Diff Fun	63
12.3.1 Diff Any Commits or Branches	63
12.3.2 Diffing Order	64
12.3.3 Diffing with Parent Commit	65
12.3.4 More Context	65
12.3.5 Just the File Names	65
12.3.6 Ignoring Whitespace	65
12.3.7 Just Certain Files	65
12.3.8 Inter-branch Diffs	66
12.4 Difftool	66
13 Renaming and Removing Files	67
13.1 Renaming Files	67
13.2 Unrenaming Files from the Stage	67
13.3 Removing Files	68
13.4 Unremoving Files from the Stage	68
13.5 Unremoving Files from Earlier Commits	69
13.6 A Note on Removing Secrets	70
14 Collaboration across Branches	72
14.1 Communication and Delegation	73
14.2 Approach: Everyone Uses One Branch	73
14.3 Approach: Everyone Uses Their Own Branch	73
14.4 Approach: Everyone Merges to the Dev Branch	74
15 Rebasing: Moving Commits	77
15.1 Contrasted to Merging	77
15.2 How it Works	78
15.3 When Should I Do This?	79
15.4 Pulling and Rebasing	79
15.5 Conflicts	80
15.6 Squashing Commits	83
15.6.1 Squash versus Fixup	86
15.7 Multiple Conflicts in the Rebase	86
16 Stashing: Temporarily Set Changes Aside	88
16.1 Example	88
16.2 The Stash Stack	89
16.3 Conflicts	90
16.4 Stashing New Files	91
17 GitHub: Forking and Pull Requests	92
17.1 Making a Fork	93
17.2 Making Your Changes	93
17.3 Syncing the Upstream with Your Fork	94
17.4 Making a Pull Request	95
17.5 Flipside: Merging a Pull Request	95

17.6	Making Many Pull Requests with Branches	96
17.7	Deleting a Pull Request	97
17.8	Syncing on the Command Line	98
18	Reverting: Undoing Commits	100
18.1	Performing the Revert	100
18.2	Revert Conflicts	101
18.3	Reverting Multiple Commits	102
19	Reset: Moving Branches Around	104
19.1	Soft Reset	105
19.2	Mixed Reset	107
19.3	Hard Reset	107
19.4	Reset to a Divergent Branch	107
19.5	Resetting Files	108
19.6	Pushing Branch Changes to a Remote	108
19.6.1	Forcing the Push	109
19.6.2	Example: Rewrite Public History	109
19.6.3	Example: Receiving Rewritten History	110
19.7	Resetting Without Moving HEAD	111
19.8	Resetting to Remove Credentials	111
20	The Reference Log, “reflog”	112
20.1	What Can We Use It For?	112
20.2	Looking Back at an Orphan Commit	112
20.3	Reflog Selectors	115
21	Patch Mode: Applying Partial Changes	116
21.1	Adding Files in Patch Mode	116
21.2	Resetting Files in Patch Mode	118
21.3	Other Patch Mode Commands	121
22	Cherry-Pick: Bringing in Specific Commits	122
22.1	Cherry-Pick Example	122
22.2	Cherry-Pick Conflicts	125
23	Who’s to Blame for this Code?	126
23.1	Fancier Blaming	126
24	Configuration	128
24.1	Local Configuration	129
24.2	Listing the Current Config	129
24.3	Getting, Setting, and Deleting Variables	130
24.4	Some Popular Variables	130
24.5	Editing the Config Directly	131
24.6	Conditional Configuration	132
24.7	Older Git Versions	132
25	Git Aliases	133
25.1	Creating an Alias	133
25.2	Displaying Aliases	134
25.3	Some Neat Sample Aliases	134
25.4	Seeing Git’s Alias Expansion	135
26	Changing Identity	136

26.1	Changing the User Configuration Variables	136
26.2	Changing the SSH Authentication Key	137
26.3	Changing your GPG Signing Key	137
26.4	Changing your SSH Signing Key	138
27	Amending Commits	140
27.1	Amending the Commit Message	140
27.2	Adding some Files to the Commit	141
28	Difftool	142
28.1	Configuring	143
28.2	Available Difftools	143
29	Mergetool	145
29.1	Merge Tool Operations	145
29.2	Some Example Merge Tools	146
29.3	Using Vimdiff as a Merge Tool	146
29.4	Backing up the Originals	148
30	Submodules	149
30.1	Using a Repo with Submodules	150
30.2	Creating a Submodule	150
30.3	Setting the Commit for the Submodule	152
30.4	Getting Submodule Latest	154
30.5	Updating the Actual Submodule Itself	155
30.5.1	Modify the Submodule Repo Elsewhere	155
30.5.2	Modify the Submodule Repo in the Submodule Directory	155
30.6	Getting the Submodule Status	155
30.7	Some Behind the Scenes	156
30.8	Deleting a Submodule	157
31	Tags	159
31.1	Lightweight Tags	159
31.2	Annotated Tags	160
31.3	Pushing Tags	160
31.4	Deleting Tags	160
32	Worktrees	162
32.1	Worktree Rules and Regulations	162
32.2	Making a New Worktree	163
32.3	Removing a Worktree	163
32.4	Listing Worktrees	164
32.5	Worktrees and Detached HEAD	164
33	Appendix: Making a Playground	166
33.1	Cloning Bare Repos	167
33.2	Automating Playground Builds	169
34	Appendix: Getting Out of Editors	171
35	Appendix: Errors and Scary Messages	172
35.1	Detached Head	172
35.2	Upstream Branch Name Doesn't Match Current	173
35.3	Current Branch Has No Upstream Branch	174
36	Appendix: Just Enough Vim	175

36.1	Launching Vim	175
36.2	Modal Editing	175
36.3	Going Between Modes	176
36.4	Moving the Cursor	176
36.5	More Modes	176
36.6	Command Line Mode	176
36.7	Exiting Vim	176
36.8	Learn More	177
37	Appendix: Other References	178
38	Quick Reference	180
38.1	Glossary	180
38.2	File States	181
38.3	Configuration	181
38.3.1	Set identity	181
38.3.2	Set default branch	181
38.3.3	Set default pull behavior to merge or rebase	182
38.3.4	Set default editor, difftool, and mergetool	182
38.3.5	Colorful Git output	182
38.3.6	Autocorrect	182
38.3.7	Newline translation	182
38.3.8	Aliases	183
38.4	Creating and Cloning Repos	183
38.5	Adding, Renaming, Deleting, Committing	183
38.6	Getting Status	184
38.7	Getting a Diff	184
38.8	Branches	184
38.9	Pulling and Pushing, and Fetching	185
38.10	Merging	186
38.11	Remotes	186
38.12	Ignoring Files	186
38.13	Rebasing	187
38.14	Stashing	187
38.15	Reverting	187
38.16	Resetting	187
38.17	The Reflog	188
38.18	Cherry-pick	188
38.19	Blame	188
38.20	Submodules	188
38.21	Tags	189
38.22	Worktrees	189

Chapter 1

Foreword

Hello again, everyone! In my role as an industry professional-turned-college instructor, I definitely see my fair share of students struggling with Git.

And who can blame 'em? It's a seemingly-overcomplicated system with lots of pitfalls and merge conflicts and detached heads and remotes and cherrypicks and rebases and an endless array of other commands that do who-knows-what.

Which leads us directly to the goal: let's make sense of all this and go from complete Git novice up to intermediate! We'll start off easy (allegedly) with commands mixed in with some theory of operation. And we'll see that understanding what Git does under the hood is critical to using it correctly.

And I *promise* there's definitely a chance that after you get through some of this guide, you might actually start to appreciate Git and like using it.

I've been using it for years (I'm using it for the source code for this guide right now) and I can certainly vouch for it becoming easier over time, and then, even, second nature.

But first, some boilerplate!

1.1 Audience

The initial draft of this guide was put online for the university students where I worked (or maybe still work, depending on when you're reading this) as an instructor. So it's pretty natural to assume that's the audience I had in mind.

But I'm also hoping that there are enough other folks out there who might get something of use from the guide as well, and I've written it in a more general sense with all you non-college students in mind.

This guide assumes that you have basic POSIX shell (i.e. Bash, Zsh, etc.) usage skills, i.e.:

- You know basic commands like `cd`, `ls`, `mkdir`, `cp`, etc.
- You can install more software.

It also assumes you're in a Unix-like environment, e.g. Linux, BSD, Unix, macOS, WSL, etc. with a POSIX shell. The farther you are away from that (e.g. PowerShell, Commodore 64), the more manual translation you'll have to do.

Windows is naturally the sticking point, there. Luckily Git for Windows comes with a Bash shell variant called Git Bash. You can also install WSL¹ to get a Linux environment running on your Windows box. I wholeheartedly recommend this for hacker types, since Unix-like systems are hacker-awesome, and additionally I recommend you all become hacker types.

¹<https://learn.microsoft.com/en-us/windows/wsl/>

1.2 Official Homepage

This official location of this document is (currently) <https://beej.us/guide/bggit/>².

1.3 Email Policy

I'm generally available to help out with email questions so feel free to write in, but I can't guarantee a response. I lead a pretty busy life and there are times when I just can't answer a question you have. When that's the case, I usually just delete the message. It's nothing personal; I just won't ever have the time to give the detailed answer you require.

As a rule, the more complex the question, the less likely I am to respond. If you can narrow down your question before mailing it and be sure to include any pertinent information (like platform, compiler, error messages you're getting, and anything else you think might help me troubleshoot), you're much more likely to get a response.

If you don't get a response, hack on it some more, try to find the answer, and if it's still elusive, then write me again with the information you've found and hopefully it will be enough for me to help out.

Now that I've badgered you about how to write and not write me, I'd just like to let you know that I *fully* appreciate all the praise the guide has received over the years. It's a real morale boost, and it gladdens me to hear that it is being used for good! :-) Thank you!

1.4 Mirroring

You are more than welcome to mirror this site, whether publicly or privately. If you publicly mirror the site and want me to link to it from the main page, drop me a line at beej@beej.us.

1.5 Note for Translators

If you want to translate the guide into another language, write me at beej@beej.us and I'll link to your translation from the main page. Feel free to add your name and contact info to the translation.

Please note the license restrictions in the Copyright and Distribution section, below.

1.6 Copyright and Distribution

Beej's Guide to Git is Copyright © 2024 Brian "Beej Jorgensen" Hall.

With specific exceptions for source code and translations, below, this work is licensed under the Creative Commons Attribution-Noncommercial-No Derivative Works 3.0 License. To view a copy of this license, visit <https://creativecommons.org/licenses/by-nc-nd/3.0/> or send a letter to Creative Commons, 171 Second Street, Suite 300, San Francisco, California, 94105, USA.

One specific exception to the "No Derivative Works" portion of the license is as follows: this guide may be freely translated into any language, provided the translation is accurate, and the guide is reprinted in its entirety. The same license restrictions apply to the translation as to the original guide. The translation may also include the name and contact information for the translator.

The programming source code presented in this document is hereby granted to the public domain, and is completely free of any license restriction.

Educators are freely encouraged to recommend or supply copies of this guide to their students.

Contact beej@beej.us for more information.

²<https://beej.us/guide/bggit/>

1.7 Dedication

The hardest things about writing these guides are:

- Learning the material in enough detail to be able to explain it
- Figuring out the best way to explain it clearly, a seemingly-endless iterative process
- Putting myself out there as a so-called *authority*, when really I'm just a regular human trying to make sense of it all, just like everyone else
- Keeping at it when so many other things draw my attention

A lot of people have helped me through this process, and I want to acknowledge those who have made this book possible:

- Everyone on the Internet who decided to help share their knowledge in one form or another. The free sharing of instructive information is what makes the Internet the great place that it is.
- Everyone who submitted corrections and pull-requests on everything from misleading instructions to typos.

Thank you! ♥

Chapter 2

Git Basics

Welcome to the *Beej's Guide to Git!*

This guide has two goals, in no particular order:

1. Help you get some familiarity with Git syntax on the command line.
2. Help you get a mental model that describes how Git stores its information.

I feel the second of these is very important for becoming even remotely adept at using Git, which is why I spend so much time talking about it. Yes, you can get by with a cheat-sheet of common Git commands, but if you want to fearlessly use the tool to its full effectiveness, you gotta learn the internals!

And, yes, Git is complex. There's a *lot* to it. But like with many complex tools, there's a lot of power to be found there if you put in the time to get good at it.

2.1 What is Git?

Git is a *source code control system*, also known as a *version control system*.

Clear? Okay, not really? Let's dive in a bit more, then!

Git's main job is to keep a log of *snapshots* of the current state of all your source code in a particular directory tree. A snapshot is the current state of all tracked files at a particular time. If you wanted to see what your source code looked like last Wednesday, you could go back in time and see it.

The idea is that you'll make some changes (to implement a feature, for example), and then you'll *commit* those changes to the *source code repo* (repository) once the feature is ready. This saves the changes to the repo and allows other collaborators to see them.

And if you ever change something you didn't want to, or you want to see how things were implemented in the past, you can always check out a previous commit and take a look.

Git keeps a history of all the commits you've ever made. Assuming nothing criminal is happening, this should be a great relief to you; if you accidentally delete a bunch of code, you can look at a previous commit and get it all back.

But that's not all! As we'll see, Git also works well as a remote backup mechanism, and works wonderfully when cooperating with a team on the same codebase.

2.1.1 Definitions

- **Source Code Control System/Version Control System:** Software that manages changes to a software project potentially consisting of thousands of source files edited by potentially hundreds of developers.

Git is a source code control system. There are many others.

- **Commit:** An explicit moment in time where a snapshot of the contents of all the source files are recorded in the source code control system. Very, very typically the code is in a working state when the commit is made; in other words, the commit represents in some ways a seal of approval that the repo in this state is in working order even if the changes aren't complete.

Example commits might be:

- “Add feature X to the codebase”
 - “Fix bug Y”
 - “Merge other contributor’s changes into the codebase”
 - “Partially complete the Spanish translation”
- **Repo/Source Code Repository:** This is where a particular software project is stored in the source code control system. Typically each project has its own repo. For example, you might “create a Git repo” to hold a new project you’re working on.

Sometimes repos are local to your computer, and sometimes they’re stored on other, remote computers.

2.2 What is GitHub?

GitHub¹ is **not** Git.

2.3 What is GitHub?

Oh, more?

GitHub is a website that provides a front end to a lot of Git features, and some additional GitHub-specific features, as well.

It also provides remote storage for your repo, which acts as a backup.

Takeaway: GitHub is a web-based front-end to Git (specifically one that works on the copy of your repo at GitHub—stay tuned for more on that later).

What about GitLab and Gitea? GitLab^a is a competitor to GitHub. Gitea^b is an open-source competitor that allows you to basically run a GitHub-like front-end on your own server. None of this information is immediately important.

^a<https://gitlab.com>

^b<https://docs.gitea.com/>

Regardless of whatever repos you have on GitHub, you’ll also have copies (known as *clones*) of those repos on your local system to work on. Periodically, in a common workflow, you’ll sync your clone of the repo with GitHub.

You don’t need GitHub. Even though you might be commonly using GitHub, there’s no law that says you have to. You can just create and destroy repos on your local system all you want, even if you’re not connected to the Internet. See Appendix: Making a Playground for more information once you’re more comfortable with the basics.

2.4 The Most Basic Git Workflow

There’s a super-common workflow that you’ll use repeatedly:

¹<https://github.com/>

1. *Clone* a *remote* repo. The remote repo is commonly on GitHub, but not necessarily.
2. Make some local changes in your *working tree*, where the project files are on your computer.
3. Add those changes to the *stage* (AKA the *index*).
4. *Commit* those changes.
5. *Push* your commit back to the remote repo.
6. Go back to Step 2.

This is not the only workflow; there are others that are also not uncommon.

2.4.1 Definitions

- **Clone** (verb): to make a copy of a remote repo locally.
- **Clone** (noun): a local copy of a remote repo.
- **Remote**: In Git, a clone of a repo in another location.
- **Working Tree**: The directory that you go into to edit and change the files of the project. This is created when you clone.
- **Stage**: In Git, a place you add copies of files to in preparation for a commit. The commit will include all the modified files that you've placed on the stage. It will not include modified files you haven't placed on the stage.
- **Index**: A less-common name for the stage.

2.5 What is Cloning?

First, some backstory.

Git is what's known as a *distributed* version control system. This means that, unlike many version control systems, there's no one central authority for the data. (Though commonly Git users treat a site like GitHub in this regard, loosely.)

Instead, Git has *clones* of repos. These are complete, standalone copies of the entire commit history of that repo. Any clone can be recreated from any other. None of them are more powerful than any others.

Looking back at The Most Basic Git Workflow, above, we see that Step 1 is to clone an existing repo.

If you're doing this from GitHub, it means you're making a local copy of an entire, existing GitHub repo.

Making a clone is a one time-process, typically (though you can make as many as you want).

2.5.1 Definitions

- **Distributed Version Control System**: A VCS in which there is no central authority of the data, and multiple clones of a repo exist.

This means after you clone a repo, there are two: one that is remote, and one that is local to your computer.

These clones are completely separate and changes you make to your local repo will not be reflected in the remote clone. Unless, that is, you explicitly make them interact.

2.6 How Do Clones Interact?

After you make a clone, there are two major operations you typically use:

- **Push**: This takes your local commits and uploads them to the remote repo.

- **Pull:** This takes the remote commits and downloads them to your local repo.

Behind the scenes, there's a process going on called a *merge*, but we'll talk more about that later.

Until you push, your local changes aren't visible on the remote repo.

Until you pull, the changes on the remote repo aren't visible on your local repo.

2.7 Actual Git Usage

Let's put all this into play. This section assumes you have the command line Git tools installed. It also generally assumes you're running a Unix shell like Bash or Zsh.

Where do you get these shells? Linux/BSD/Unix and Mac users will already have these shells. Yay! Recommendation for Windows users is to install and run Ubuntu with WSL^a to get a virtual Linux installation. Or, if you don't want to jump down that particular rabbit hole just yet, run Git Bash (included with Git).

^a<https://learn.microsoft.com/en-us/windows/wsl/>

For this example, we'll assume we have a GitHub repo already in existence that we're going to clone.

Recall the process in The Most Basic Git Workflow, above:

1. *Clone* a *remote* repo. The remote repo is commonly on GitHub, but not necessarily.
2. Make some local changes.
3. Add those changes to the *stage*.
4. *Commit* those changes.
5. *Push* your commit back to the remote repo.
6. Go back to Step 2.

2.7.1 Step 0: One-time Setup

“Wait! You didn't say there was a Step 0!”

Yes, one time, before you start using Git, you should tell it what your name and email address are. These will be attached to the commits you make to the repo.

You can change them any time in the future, and you can even set them on a per-repo basis. But for now, let's set them globally so Git doesn't complain when you make a commit.

You just have to do this once then never again (unless you want to).

Type both of these on the command line, filling in the appropriate information.

In this guide, things you type at the shell prompt are indicated by a prefaced \$. Don't type the \$; just type what follows it. Your actual shell prompt might be % or \$ or something else, but here we use the \$ to indicate it.

```
$ git config set --global user.name "Your Name"
$ git config set --global user.email "your-email@example.com"
```

If you need to change them in the future, just run those commands again.

If you get an error with the above commands you might be running an older version of Git. Try them again, but leave out the word `set`. Or, better yet, see if you can get a newer version of Git.

Finally, let's set the default branch name. It's really too early to explain what that means, but let's run this command and set the name to `main`. This will keep Git from complaining when you create a repo.

```
$ git config set --global init.defaultBranch main
```

Some repos use `master` for the default branch name instead of `main`. It's actually an arbitrary choice, and repo creators can use anything they want. Git itself hints, "Names commonly chosen instead of 'master' are 'main', 'trunk' and 'development'."

I'm suggesting using `main` for multiple reasons, not the least of which is that's what GitHub uses, but it's up to you. In this guide I'll use `main`.

2.7.2 Step 1: Clone an Existing Repo

Let's clone a repo! Here's an example repo you can actually use. Don't worry—you can't mess anything up on the remote repo even though (and because) you don't own it.

Like we said before, this isn't the only workflow. Sometimes people make a local repo first, add some commits, then create a remote repo and push those commits. But for this example, we'll assume the remote repo exists first, though this isn't a requirement.

Switch into a subdirectory where you want the clone created. This command will create a new subdirectory out of there that will hold all the repo files.

(In the example, anything that begins with `$` represents the shell prompt indicating this is input, not output. Don't type the `$`; just type in the part after it.)

```
$ git clone https://github.com/beejjorgensen/git-example-repo.git
```

You should see some output similar to this:

```
Cloning into 'git-example-repo'...
remote: Enumerating objects: 10, done.
remote: Counting objects: 100% (10/10), done.
remote: Compressing objects: 100% (8/8), done.
remote: Total 10 (delta 2), reused 9 (delta 1), pack-reused 0 (from 0)
Receiving objects: 100% (10/10), done.
Resolving deltas: 100% (2/2), done.
```

Congratulations! You have a clone of the repo. Let's have a peek:

```
$ cd git-example-repo
$ ls -la
```

And we see a number of files:

```
total 16
drwxr-xr-x  5 beej  staff  160 Jan 18 13:35 .
drwxr-xr-x 106 beej  staff 3392 Jan 18 13:35 ..
drwxr-xr-x 12 beej  staff  384 Jan 18 13:35 .git
-rw-r--r--  1 beej  staff  162 Jan 18 13:35 README.md
-rwxr-xr-x  1 beej  staff   75 Jan 18 13:35 hello.py
```

There are two files in this repo: `README.md` and `hello.py`.

The directory `.git` has special meaning; it's the directory where Git keeps all its metadata and commits. You can look in there, but you don't have to. If you do look, don't change anything. The

| only thing that makes a directory a Git repo is the presence of a valid `.git` directory within it.

Let's ask Git what it thinks the current status of the local repo is:

```
$ git status
```

Gives us:

```
On branch main
Your branch is up to date with 'origin/main'.

nothing to commit, working tree clean
```

There's a lot of information here, surprisingly.

We haven't talked about branching yet, but this is letting us know we're on branch `main`. That's fine for now.

It also tells us this branch is up to date with a branch called `origin/main`. A branch in Git is just a reference to a certain commit that's been made, like a Post-It note attached to that commit. (Recall that a commit is a snapshot of the code repo at some time.)

We don't want to get caught up in the intricacies of branching right now, but bear with me for a couple paragraphs.

`origin` is an alias for the remote repository that we originally cloned from, so `origin/main` corresponds to "branch `main` on the repo you originally cloned from"².

There is one important thing to notice here: there are two `main` branches. There's the `main` branch on your local repo, and there's a corresponding `main` branch on the remote (`origin`) repo³.

Remember how clones are separate? That is, changes you make on one clone aren't automatically visible on the other? This is an indication of that. You can make changes to your local `main` branch, and these won't affect the remote's `main` branch. (At least, not until you push those changes!)

Lastly, it mentions we're up-to-date with the latest version of `main` on `origin` (that we know of), and that there's nothing to commit because there are no local changes. We're not sure what that means yet, but it all sounds like vaguely good news.

2.7.3 Step 2: Make Some Local Changes

Let's edit a file and make some changes to it.

| **Again, don't worry about messing up the remote repo**—you don't have permissions to do that. Your safety is completely assured from a Git perspective.

If you're using VS Code, you can run it in the current directory like so:

```
$ code .
```

Otherwise, open the code in your favorite editor, which, admit it, is Vim⁴.

Let's change `hello.py`:

It was:

²We're glazing over an important topic here that we'll come back to later called *remote tracking branches*.

³And again we're doing some hand-waving. There are actually three branches. Two of them, `main` and `origin/main` are on your local clone. And there's a third `main` on the remote `origin` that your `origin/main` is *tracking*. Feel free to ignore this detail until we get to the remote tracking branch chapter.

⁴<https://www.vim.org/>

```
1 #!/usr/bin/env python
2
3 print("Hello, world!")
4 print("This is my program!")
```

but let's add a line so it reads:

```
1 #!/usr/bin/env python
2
3 print("Hello, world!")
4 print("This is my program!")
5 print("And this is my modification!")
```

And save that file.

Let's ask Git what the status is now.

```
$ git status
On branch main
Your branch is up to date with 'origin/main'.

Changes not staged for commit:
  (use "git add <file>..." to update what will be committed)
  (use "git restore <file>..." to discard changes in working
  directory)
    modified:   hello.py

no changes added to commit (use "git add" and/or "git commit -a")
```

This is telling us a couple important things.

First, Git has detected that we modified a file, namely `hello.py`, which we did.

But it also says there are `no changes added to commit` (i.e. “there is nothing to make a commit with”). What does that mean?

It means we haven't added any modified files to the *stage* yet. Recall that the stage is where we can place items that we wish to include in the next commit. Let's try that.

2.7.3.1 Step 2.1: Reviewing Your Changes

We're going to divert for just a moment to briefly introduce a new optional tool: `git diff` (short for “difference”, though we still pronounce it “diff”).

If you make some changes to files and you need a refresher on all the things you've changed, you can run this command to see it. But, fair warning, the output is... *esoteric*.

Let's try it.

```
$ git diff
diff --git a/hello.py b/hello.py
index 9db78d2..1187d32 100755
--- a/hello.py
+++ b/hello.py
@@ -2,3 +2,4 @@
```

```
print("Hello, world!")
print("This is my program!")
+print("And this is my modification!")
```

What the heck is this sorcery? If you're lucky, it got color-coded for you with (by convention) added lines in green and deleted lines in red.

For now, just notice a couple things:

1. The file name. We see this change was to `hello.py`.
2. The line with the `+` at the front. This indicates an added line.

A `-` at the front of a line would indicate the line was deleted. And changed lines are often shown as the old line being deleted and a new one added.

Finally, if you want to see the diff for things you've added to the stage already (in the next step), you can run `git diff --staged`.

We'll dive more into diff later, but I wanted to introduce it here since it's so useful.

2.7.4 Step 3: Add Changes to the Stage

The Git status message, above, is trying to help us out. It says:

```
no changes added to commit (use "git add" and/or "git commit -a")
```

It's suggesting that `git add` will add things to the stage—and it will.

Now we, the developers, know that we modified `hello.py`, and that we'd like to make a commit that reflects the changes to that file. So we need to first add it to the stage so that we can make a commit.

Let's do it with `git add`:

```
$ git add hello.py
$ git status
On branch main
Your branch is up to date with 'origin/main'.

Changes to be committed:
  (use "git restore --staged <file>..." to unstage)
    modified:   hello.py
```

Now it's changed from saying "Changes not staged for commit" to saying "Changes to be committed", so we have successfully copied `hello.py` to the stage!

There's also a helpful message there about how to *unstage* the file. Let's say you accidentally added it to the stage and you changed your mind and wanted to not include it in the commit after all. You can run

```
$ git restore --staged hello.py
```

and that will change it back to the "Changes not staged for commit" state.

2.7.5 Step 4: Commit those Changes

Now that we have something copied to the stage, we can make a commit. Recall that a commit is just a snapshot of the state of the repo given the modified files on the stage. Modified files not on the stage will not be included in the snapshot. Unmodified files are automatically included in the snapshot.

In short, the commit snapshot will contain all the unmodified files Git currently tracks **plus** the modified files that are on the stage. (Git just doesn't show all the unmodified files with `status` because the output would be completely unhelpful.)

Let's do it:

```
$ git commit -m "Add another print line"
[main 0e1ad42] Add another print line
1 file changed, 1 insertion(+)
```

The `-m` switch allows you to specify a commit message. If you don't use `-m`, you'll be popped into an editor, which will probably be Nano or Vim, to edit the commit message. If you're not familiar with those, see [Getting Out of Editors](#) for help.

If you do get into the editor, know that every line in the commit message that begins with `#` is a comment that is ignored for the purposes of the commit. It's a little weird that the commit message is a comment about the commit, and then you can have commented-out lines in the comment, but I don't make the rules!

And that's good news! Let's check the status:

```
$ git status
On branch main
Your branch is ahead of 'origin/main' by 1 commit.
  (use "git push" to publish your local commits)

nothing to commit, working tree clean
```

“Nothing to commit, working tree clean” means we have no local changes to our branch.

Turns out there's an optional shortcut here. If you've modified a file, you can just commit it directly (without adding it to the stage!) by naming it on the command line.

Let's say you modified `foo.txt` but didn't add it. You could:

```
$ git commit -m "jerbify the flurblux" foo.txt
```

And that would make the commit directly, bypassing the whole add-it-to-the-stage step. But you can only do this with files that the repo already is aware of, i.e. they aren't “untracked”.

You can specify multiple files here, or a directory. Also, this doesn't affect files that are already on the stage.

But look! The status says we're “ahead of ‘origin/main’ by 1 commit”! This means our local commit history on the `main` branch has one commit that the remote commit history on its `main` branch does not have.

Which makes sense—the remote repo is a clone and so it's independent of our local repo unless we explicitly try to sync them up. It doesn't magically know that we've made changes to our local repo.

And Git is helpfully telling us to run `git push` if we want to update the remote repo so that it also has our changes.

So let's try to do that. Let's push our local changes to the remote repo.

2.7.6 Step 5: Push Your Changes to the Remote Repo

Let's push our local changes to the remote repo:

```
$ git push
```

And that produces:

```
Username for 'https://github.com':
```

Uh oh—trouble brewing. Let's try entering our credentials:

```
Username for 'https://github.com': my_username
Password for 'https://bejjorgensen@github.com': [my_password]
remote: Support for password authentication was removed on August
13, 2021.
remote: Please see https://docs.github.com/en/get-started/getting-
started-with-git/about-remote-repositories#cloning-with-
https-urls for information on currently recommended modes
of authentication.
fatal: Authentication failed for 'https://github.com/bejjorgensen/
git-example-repo.git/'
```

Well, that's all kinds of not-working. Largely this is because you don't have permission to write to that repo since you're not the owner. And, notably, support for authenticating with a password seems to have been removed in 2021 which, last I checked, was in the past.

So what do we do? Firstly, we should be the owner of the GitHub repo that we've cloned and that'll solve some of the permission problems. Secondly, we'd better find another way to authenticate ourselves to GitHub that's not plain password.

Let's try that in the next section.

Chapter 3

GitHub: How To Use It

Now, we’ve said that GitHub (which is a proprietary web front-end to Git run and owned by Microsoft) is not Git, and it’s true. It’s also true that you never even need to touch GitHub in order to use Git.

That said, it’s *really* common for people to use GitHub, so we’ll get it set up in this chapter.

Here we’ll make a new GitHub account and see how authentication works. This involves some one-time setup.

If you already have a GitHub account, you can skip that section.

If you already have authentication set up with GitHub CLI or with SSH keys, you can skip that section, as well.

If you don’t need to use GitHub, you can skip the entire chapter!

3.1 Making a GitHub Account

Head on over to GitHub¹ and click `Sign Up`. Follow those instructions.

Eventually you’ll end up on your home screen dashboard.

3.2 Creating a New Repo on GitHub

This will make a repository on GitHub that you own. It does not make a local repository—you’ll have to clone the repo for that, something we’ll do later.

In GitHub, there’s a green `New` button on the left of the dashboard.

Also, there’s a `+` pulldown on the upper right center that has a “New Repository” option. Click one of those.

On the subsequent page:

1. Enter a “Repository name”, which can be anything as long as you don’t already have a repo by that name. Let’s use `test-repo` for this example.
2. Check the “Add a README file” checkbox.

(In the future, you might already have a local repo you’re going to push to this new repo. If that’s the case, do **not** check this box or it’ll prevent the push from happening.)
3. Click `Create repository` at the bottom.

¹<https://github.com/>

And there you have it.

3.3 Authentication

Before we get to cloning, let's talk authentication. In the previous part of the intro, we saw that username/password logins were disabled, so we have to do something different.

There are a few options:

- Use a tool called GitHub CLI
- Use SSH keys
- Use Personal Authentication Tokens

GitHub CLI is likely easier. SSH keys are geektacular. I only recently learned that you could authenticate with personal access tokens, so I can't really speak to them much.

Personally, I use SSH keys. But other people... don't. It's up to you.

If you already have authentication working with GitHub, skip these sections.

Otherwise, choose one of them (like SSH) and use it.

3.3.1 GitHub CLI

This is a command line interface to GitHub. It does a number of things, but one of them is providing an authentication helper so you can do things like actually push to a remote repo.

Visit the GitHub CLI page² and follow the installation instructions. If you're using WSL, Linux, or another Unix variant, see their installation instructions³ for other platforms.

Once you have it installed, you should be able to run 'gh --version' and see some version information, e.g.:

```
$ gh --version
gh version 2.42.1 (2024-01-15)
https://github.com/cli/cli/releases/tag/v2.42.1
```

Then you'll want to run the following two commands:

```
$ gh auth login
$ gh auth setup-git
```

The first command (`login`) will take you through the login process. You'll have to do this again if you log out.

It's going to ask you if you want to use SSH or HTTP. If you have SSH keys set up, I recommend using that. If you don't, choose "HTTP" when it asks. The main difference is that with HTTP, the login credentials are stored unencrypted, whereas with SSH, you can protect them with a passphrase. See below for setting up SSH keys.

And logging in with a web browser is easiest, when it asks.

The second command (`setup-git`) is one-time only. This just adds to your global config some stuff to help with authentication.

²<https://cli.github.com/>

³<https://github.com/cli/cli#installation>

3.3.2 SSH Keys

If you don't want to install and use GitHub CLI, you can take this approach instead. This is more involved, but has more geek cred. This is what I use.

If you already have an SSH keypair, you can skip the key generation step. You'd know you had one if you ran `ls ~/.ssh` and you saw a file like `id_rsa.pub` or `id_ed25519.pub`.

To make a new keypair, run the following command:

```
$ ssh-keygen -t ed25519 -C youremail@example.com
```

(The `-C` sets a "comment" in the key. It can be anything, but an email address is common.)

This results in a lot of prompts, but you can just hit ENTER for all of them.

Best practice is to use a password to access this key, otherwise anyone with access to the private key can impersonate you and access your GitHub account, and any other account you have set up to use that key. But it's a pain to type the password every time you want to use the key (which is any time you do anything with GitHub from the command line), so people use a *key agent* which remembers the password for a while.

If you don't have a password on your key, you're relying on the fact that no one can get a copy of the private portion of your key that's stored on your computer. If you're confident that your computer is secure, then you don't need a password on the key. Do you feel lucky?

Setting up the key agent is outside the scope of this document, and the author is unsure of how it even works in WSL. GitHub has documentation on the matter^a.

For this demo, we'll just leave the password blank. All of this can be redone with a new key with a password if you choose to do that later.

^a<https://docs.github.com/en/authentication/connecting-to-github-with-ssh/generating-a-new-ssh-key-and-adding-it-to-the-ssh-agent>

Anyway, just hitting ENTER for all the prompts gets you something like this:

```
Generating public/private ed25519 key pair.
Enter file in which to save the key (/home/user/.ssh/id_ed25519):
Enter passphrase (empty for no passphrase):
Enter same passphrase again:
Your identification has been saved in id_ed25519
Your public key has been saved in id_ed25519.pub
The key fingerprint is:
SHA256:/lrT43BQBRPjPuxpTBFInhdTzSjQwxU4USwt5c0Lw user@localhost
The key's randomart image is:
+--[ED25519 256]--+
|      .o.X^%^^=+|
|      ..00*^.=o|
|      ..o = o..|
|      . + E   |
|      S .     |
|      .  o    |
|      . + +   |
|      o = .   |
|      ... .   |
+-----[SHA256]-----+
```

If you chose any file name other than the default for your key, you'll have to do some additional configuration to get it to work with GitHub^a.

^a<https://www.baeldung.com/linux/ssh-private-key-git-command>

What's that randomart thing with all the weird characters? It's a visual representation of that key. There are ways to configure SSH so that you see the randomart every time you log in. And the idea is that if one day you see it looks different, something could be amiss security-wise. I doubt most people every look at it again once it's been generated, though.

Now if you type `ls ~/.ssh` you should see something like this:

```
id_ed25519    id_ed25519.pub
```

The first file is your *private key*. This is never to be shared with anyone. You have no reason to even copy it.

The second file is your *public key*. This can be freely shared with anyone, and we're going to share it with GitHub in a second so that you can log in with it.

If you have trouble in the following subsections, try running these two commands:

```
$ chmod 700 ~/.ssh
$ chmod 600 ~/.ssh/*
```

You only have to do that once, but SSH can be a bit picky if the file permissions on those files aren't locked down.

Now in order to make this work, you have to tell GitHub what your public key is.

First, get a copy of your public key in the clipboard. **Be sure you're getting the file with the `.pub` extension!**

```
$ cat ~/.ssh/id_ed25519.pub
```

You should see something like this:

```
ssh-ed25519 AAAC3N[a bunch of letters]V+znp00 youremail@example.com
```

Copy the entire thing into the clipboard so you can paste it later.

Now go to GitHub, and click on your avatar icon in the upper right.

Choose "Settings".

Then on the left, choose "SSH and GPG keys".

Click "New SSH Key".

For the title, enter something identifying, like, "My laptop key".

Key type is "Authentication Key".

Then paste your key into the "Key" field.

And click "Add SSH key".

We'll be using SSH to clone URLs later. Remember that.

3.3.3 Using Personal Access Tokens

Remember last chapter when we tried to clone an HTTPS repo URL on the command line and it prompted for a username and password that didn't work?

Well, we get to actually make new passwords that *will* work in that case. They're called *personal access tokens*.

GitHub has a lot of documentation on this⁴ but the gist of it is that you're going to create a *token* that represents some kind of access, e.g. "ability to read and write my repos", and you're going to use that in lieu of the password on the command line.

So that last failed example would look like this:

```
Username for 'https://github.com': [MY USERNAME]
Password for 'https://beejjorgensen@github.com': [MY TOKEN]
```

In other words:

1. Generate a token.
2. Use that token as your password.

Your computer might automatically save those credentials so you don't have to enter them every time. Or it might not.

One of the main things personal access tokens can give you is fine-grained control over access. You can limit access to read-only, or just to certain repos, and so on.

Additionally, you can use GitHub CLI authentication with a token as well. You just have to feed it in there on standard input. Let's say you have your token in a file called `mytoken.txt`. You can authenticate with GitHub CLI like so:

```
$ gh auth login --with-token < mytoken.txt
```

Like with SSH keys, if you lose a laptop that uses a particular access token, you can simply invalidate that token through GitHub's UI so that mean people can't use it.

3.4 Make a Local Clone of the Repo

We need to figure out the URL to the repo so we can clone it.

If you click on your icon in the upper right, then "My Repositories", you should see a page with all your repos. At this point, it might just be your `test-repo` repo. Click on the name.

And you should then be on the repo page. You can browse the files here, among other things, but really we want to get the clone URL.

Click the big blue "Code" button.

What you do next depends on if you're using GitHub CLI or SSH keys.

3.4.1 Cloning from GitHub with GitHub CLI

You have two options.

- **Option 1:** Earlier when we authenticated with `gh auth login` I said to remember if you chose HTTPS or SSH. Depending on which you chose, you should choose that tab on this window.

Copy the URL.

Go to the command line and run `git clone [URL]` where `[URL]` is what you copied. So it'll be this for HTTPS:

⁴<https://docs.github.com/en/authentication/keeping-your-account-and-data-secure/managing-your-personal-access-tokens>

```
$ git clone https://github.com/user/test-repo.git
```

or this for SSH:

```
$ git clone git@github.com:user/test-repo.git
```

- **Option 2:** Choose the “GitHub CLI” tab. Run the command as they have it, which will be something like:

```
$ gh repo clone user/test-repo
```

3.4.2 Cloning from GitHub with SSH Keys

If you set up an SSH key earlier, you can use this method.

After hitting the green “Code” button, make sure the “SSH” tab is selected.

Copy that URL.

Go to the command line and run `git clone [URL]` where `[URL]` is what you copied. So it’ll be something like this:

```
$ git clone git@github.com:user/test-repo.git
```

3.5 Make Changes and Push!

Now that you’ve cloned the repo, you should be able to `cd` into that directory, edit a file, `git add` it to the stage, then `git commit -m message` to make a commit...

And then `git push` to push it back to the clone on GitHub!

And after that if you go to the repo page on GitHub and hit reload, you should be able to see your changes there!

And now we’re back to that standard common flow:

1. Clone a remote repo.
2. Make some local changes.
3. Add those changes to the *stage*.
4. Commit those changes.
5. Push your changes back to the remote repo.
6. Go back to Step 2.

3.6 Collaboration on GitHub

There are two main techniques for this:

1. Fork/pull request
2. Add a collaborator

We’ll talk about the first one in the future.

For now, the easiest way to add collaborators is to just add them to your repo.

On the repo page on GitHub, choose “Settings”, then “Collaborators” on the left.

After authenticating, you can click “Add people”. Enter the username of the person you want to collaborate with.

They’ll have to accept the invitation from their GitHub inbox, but then they’ll have access to the repo.

Be sure to only do this with people you trust!

Chapter 4

The Git Log and HEAD

When we make commits to a Git repo, it tracks each of those commits in a log that you can visit. Let's take a look at that now.

4.1 An Example Log

You can get the commit log by typing `git log`.

Let's say I'm in a repo with a single commit where I've just added a file with the commit message "Added".

```
$ git log
```

produces:

```
commit 5a02fede3007edf55d18e2f9ee3e57979535e8f2 (HEAD -> main)
Author: User Name <user@example.com>
Date: Thu Feb 1 09:24:52 2024 -0800

    Added
```

If I make another commit, we get a longer log:

```
commit 5e8cb52cb813a371a11f75050ac2d7b9e15e4751 (HEAD -> main)
Author: User Name <user@example.com>
Date: Thu Feb 1 12:36:13 2024 -0800

    More output

commit 5a02fede3007edf55d18e2f9ee3e57979535e8f2
Author: User Name <user@example.com>
Date: Thu Feb 1 09:24:52 2024 -0800

    Added
```

Notice that the most recent commit entry is at the top of the output.

4.2 What's in the log?

There are a few things to notice in the log:

- The commit comment
- The date
- The user who made the commit

Also, we have those huge hex¹ numbers after the word `commit`.

This is the *commit ID* or *commit hash*. This is a universally unique number that you can use to identify a particular commit.

Normally you don't need to know this, but it can be useful for going back in time or keeping track of commits in multi-developer projects.

We also see a bit at the top that says `(HEAD -> main)`. What's that about?

4.3 The HEAD Reference

We've seen that each commit has a unique and unwieldy identifier like this:

```
5a02fede3007edf55d18e2f9ee3e57979535e8f2
```

Luckily, there are a few ways to refer to commits with more-human symbolic names.

HEAD is one of these references. It indicates which branch or commit you're looking at right now in your project subdirectory². Remember how we said you could go look at previous commits? The way you do that is by moving HEAD to them.

We haven't talked about branches yet, but the HEAD normally refers to a branch. By default, it's the `main` branch. But since we're getting ahead of ourselves, I'm going to just keep saying that HEAD refers to a commit, even though it usually does it indirectly via a branch.

So this is a bit of a lie, but I hope you forgive me.

Some terminology: the Git subdirectory you're looking at right now and all the files within it is referred to as your *working tree*. The working tree is the files as they appear at the commit pointed to by HEAD, plus any uncommitted changes you might have made.

So if you switch HEAD to another commit, the files in your working tree will be updated to reflect that.

Importantly, the data in the files in the working tree might differ from the data in the files at the current commit pointed to by HEAD. This happens when you've modified a file in the working tree but haven't yet committed it.

Okay then, how do we know which commit HEAD is referring to? Well, it's right there at the top of the log:

```
commit 5e8cb52cb813a371a11f75050ac2d7b9e15e4751 (HEAD -> main)
Author: User Name <user@example.com>
Date: Thu Feb 1 12:36:13 2024 -0800
```

More output

We see HEAD right there on the first line, indicating that HEAD is referring to commit with ID:

¹<https://en.wikipedia.org/wiki/Hexadecimal>

²I'm stretching it a bit, here. HEAD looks at the commit you've switched to. This might not be quite the same as what's in your project subdirectory if you've modified some of the files since the moving HEAD to that commit. The commit is a snapshot, but that snapshot doesn't include modifications to files until you make another commit that contains them.

```
5e8cb52cb813a371a11f75050ac2d7b9e15e4751
```

Again, that's a bit of a lie. The HEAD -> main means that HEAD is actually referring to the main branch, and that main is referring to the commit. HEAD is therefore indirectly referring to the commit. More on that later.

4.4 Going Back In Time and Detached HEAD

Here's my full Git log:

```
commit 5e8cb52cb813a371a11f75050ac2d7b9e15e4751 (HEAD -> main)
Author: User Name <user@example.com>
Date: Thu Feb 1 12:36:13 2024 -0800
```

More output

```
commit 5a02fede3007edf55d18e2f9ee3e57979535e8f2
Author: User Name <user@example.com>
Date: Thu Feb 1 09:24:52 2024 -0800
```

Added

If I look at the files, I'll see the changes indicated by the "More output" commit. But let's say I want to go back in time to the previous commit and see what the files looked like then. How would I do that?

Maybe there were some changes that existed back in an earlier commit that had since been removed, and you wanted to look at them, for example.

I can use the `git switch` command to make that happen.

Before you switch branches, you should be all committed with `git status` telling you everything is clean. If you're not, make a commit or stash your stuff before your switch.

Let's check out the first commit, the one with ID `5a02fede3007edf55d18e2f9ee3e57979535e8f2`.

Now, I could say:

```
$ git switch --detach 5a02fede3007edf55d18e2f9ee3e57979535e8f2
```

and that would work, but the rule is that you must specify at least 4 unique digits of the ID, so I could have also done this:

```
$ git switch --detach 5a02
```

for the same result.

And that result is:

```
HEAD is now at 5a02fed
```

Let's take a look around with `git log`:

```
commit 5a02fede3007edf55d18e2f9ee3e57979535e8f2 (HEAD)
Author: User <user@example.com>
Date: Thu Feb 1 09:24:52 2024 -0800
```

```
Added
```

That’s all! Just one commit?! Where’s the second commit I made? Is it gone forever?!

No. Everything is fine. *[Soothing image of a kitten sleeping in the sun.]*

When you have HEAD at a certain commit, you’re looking at the world as it looked at that snapshot in time. Future commits haven’t “happened” yet from this perspective. They are still out there, but you’ll have to change back to them by name. (It’s like a flippin’ *time machine!*)

Also, do you see anything different about that first line that reads (HEAD)? That’s right: no main to be seen.

That’s because the main branch is still looking at the latest commit, the one with the “More output” comment. So we don’t see it from this perspective.

Furthermore, this means that HEAD is no longer *attached* to main. We call this state *detached head*. And git switch doesn’t let you do that unless you mean it, which is why we have that --detach in there. (And reattaching is easy: just switch to the branch you want to attach to.)

Remember earlier when I said it was a bit of a lie to say that HEAD points to a commit? Well, detached head state is the case where it actually **does**. Detached head state is just what happens when HEAD is pointing to a commit instead of a branch. To reattach it, you have to change it to point to a branch again.

Let’s reattach HEAD to the main branch. There are two options:

1. `git switch -:` this switches to wherever we were before this, which, in this case, was main.
2. `git switch main:` this explicitly switches to main.

Let’s try:

```
$ git switch main
Previous HEAD position was 5a02fed Added
Switched to branch 'main'
```

Notice there was no --detach in that `git switch!` We’re reattaching the head, not detaching it, so we don’t have to tell Git we know what we’re doing.

Don’t worry if you forget the --detach. Git will tell you if you need it.

```
$ git switch 5a02
fatal: a branch is expected, got commit '5a02'
hint: If you want to detach HEAD at the commit, try again with
the --detach option.
```

And now if we `git log`, we see all our changes again:

```
commit 5e8cb52cb813a371a11f75050ac2d7b9e15e4751 (HEAD -> main)
Author: User Name <user@example.com>
Date: Thu Feb 1 12:36:13 2024 -0800

    More output

commit 5a02fede3007edf55d18e2f9ee3e57979535e8f2
Author: User Name <user@example.com>
Date: Thu Feb 1 09:24:52 2024 -0800
```

```
Added
```

and our working tree will be updated to show the files as they are in the `main` commit.

And you see the `HEAD -> main`? The arrow means `HEAD` is reattached to `main`. (If `HEAD` were detached at the same commit as `main`, you'd see `HEAD, main`.)

4.5 The Old Command: `git checkout`

In ye olden days before `git switch` existed, there was a command to do all that stuff called `git checkout`. `git checkout` did a lot of things, and it still does. Because it does so much, the maintainers of Git have been trying to break some of that functionality into `git switch` and other commands.

There are still times when you need to use `checkout`, but if your version of Git supports `switch`, this isn't one of them. Use `switch` if you can and skip this section.

But let's redo the previous section by using just `git checkout` instead of `git switch`. Let's try:

```
$ git checkout 5a02
```

and it says:

```
Note: switching to '5a02fede3007edf55d18e2f9ee3e57979535e8f2'.

You are in 'detached HEAD' state. You can look around, make experimental
changes and commit them, and you can discard any commits you make in this
state without impacting any branches by switching back to a branch.

If you want to create a new branch to retain commits you create, you may
do so (now or later) by using -c with the switch command. Example:

  git switch -c <new-branch-name>

Or undo this operation with:

  git switch -

Turn off this advice by setting config variable advice.detachedHead to false

HEAD is now at 5a02fed Added
```

Well, that's a lot of scary stuff, but it's just Git telling us that we're now in detached head state. Which of course we are since we just detached the head from branch `main` by switching to a specific commit hash.

And we can get back to the `main` branch with:

```
$ git checkout main
```

You can also switch back with the aforementioned `git switch` variants, but we're pretending those don't exist for this section.

4.6 Commits Relative to HEAD

There are a couple shortcuts to get to commits that are earlier than HEAD, like, “I want to switch to the 3rd commit before this one.”

Here’s a pretty useless example that we’ll start with:

```
$ git switch --detach HEAD
```

This moves HEAD to where HEAD was. That is, it moves it nowhere. (Though it does have the effect of detaching it from the branch.)

But what if I wanted to move to the commit right *before* where HEAD is now? You can do it with *caret notation* like this:

```
$ git switch --detach HEAD^
```

And that gets you to the previous commit.

It’s apparently a little-known Fun Fact™ that you can commonly enter @ instead of HEAD with these commands. For example, the previous command could be written:

```
$ git switch --detach HEAD^
$ git switch --detach @^ # Same thing
```

Be aware that some shells might require you to put the @ in quotes to get it to work right. But that can potentially save three keystrokes.

What if you wanted to get to the *third-previous* commit? You can add more carets!

```
$ git switch --detach HEAD^^^
```

Or the 10th previous commit!

```
$ git switch --detach HEAD^^^^^^^^^^^
```

Or the 100th previous commit!

```
$ git switch --detach HEAD^^^^^^^^^^^^^^^^^^^^^^^^^^^^^^^^^^^^forget this
```

Typing all these carets is wearing me out. Luckily there’s *another* shorthand we have at our disposal with *tilde notation*. The two following lines are equivalent:

```
$ git switch --detach HEAD^^^
$ git switch --detach HEAD~3
```

After the tilde, you can just give the number of commits back you want to go. So back to my example:

```
$ git switch --detach HEAD~100 # Much easier
```

All this said, personally I usually just look at the log and go to a specific commit instead of counting back.

“But that’s just, like, my opinion, man.”
—The Dude

Chapter 5

Branches and Fast-Forward Merges

5.1 What is a Branch?

Normally you think of writing code as a linear sequence of changes. You start with an empty file, add some things, test them, add some more, test some more, and eventually the code is complete.

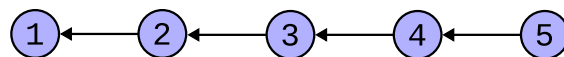

Figure 5.1: A simple commit graph.

In Git we might think of this as a sequence of commits. Let’s look at a graph (Figure 5.1) where I’ve numbered commits 1-5. There, (1) was the first commit we made on the repo, (2) is some changes we made on top of (1), and (3) is some changes we made on top of (2), etc.

Git always keeps track of the parent commit for any particular commit, e.g. it knows the parent commit of (3) is (2) in the above graph. In this graph, the parent relationship is indicated by an arrow. “The parent of commit 3 is commit 2”, etc. It’s a little confusing because clearly commit 3 came *after* commit 2 in terms of time, but the arrow points to the parent, which is the opposite of the nodes’ temporal relationship.

A *branch* is like a name tag stuck on one **specific** commit. You can move the name tag around with various Git operations.

We’re assuming the default branch is called `main`. If you haven’t done so already, configure your default branch as shown in the Git Basics chapter.

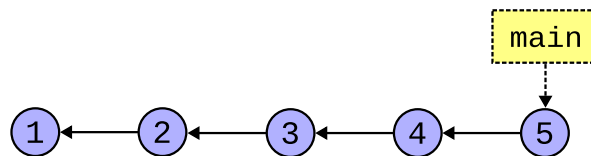

Figure 5.2: The main branch on a commit.

So to make it a little more complete, we can show that branch in Figure 5.2. There’s our `main` branch attached to the commit labeled (5).

It’s tempting to think of the whole sequence of commits as “the branch”, but this author recommends against it. Better to keep in mind that the branch is just a name tag for a single commit, and that we can move that name tag around.

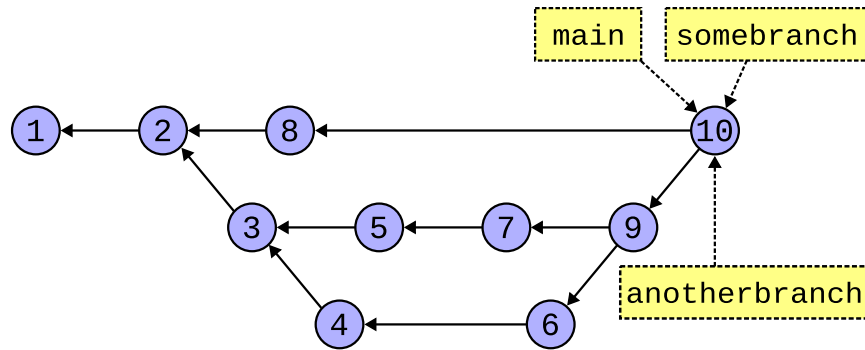

Figure 5.5: After merging all branches.

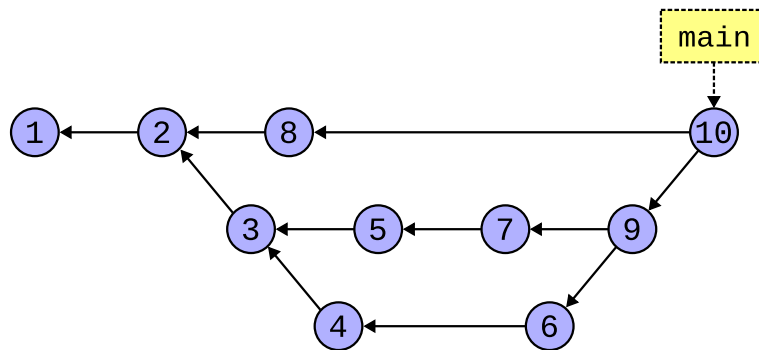

Figure 5.6: After deleting merged branches.

5.2 A Quick Note about `git pull`

When you do a pull, it actually does two things: (a) *fetch* all the changes from the remote repo and (b) *merge* those changes.

If two or more people are committing to the same branch, eventually `git pull` is going to have to merge. And it turns out there are a few ways it can do this.

For now, we're going to tell `git pull` to always classically merge divergent branches, and you can do that with this one-time command:

```
$ git config set --global pull.rebase false
```

If you don't do that, Git will pop up an error message complaining about it the first time it has to merge on a pull. And you'll have to do it then. (Leave the word `set` out of that command if it fails on older Gits.)

When we talk about rebasing later, this will make more sense.

5.3 HEAD and Branches

We said earlier that `HEAD` refers to a specific commit, namely the commit you're looking at right now in your unmodified working tree.

And we also said that was a bit of a lie.

In normal usage, `HEAD` points to a branch, not to a commit. Only in detached head state does `HEAD` point directly to a commit (i.e. when it's detached from all branches).

If we look at Figure 5.7, we see `HEAD` is pointing to a branch as per normal.

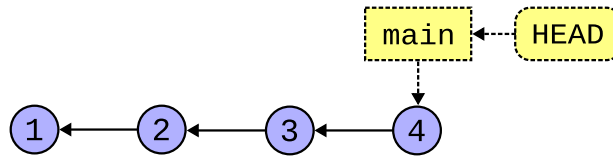

Figure 5.7: `HEAD` pointing to a branch.

But if we check out an earlier commit that doesn't have a branch, we end up in detached head state, and it looks like Figure 5.8.

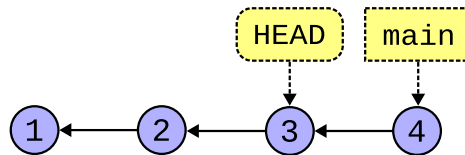

Figure 5.8: `HEAD` pointing to a commit.

So far, we've been making commits on the `main` branch without really even thinking about branching. Recalling that the `main` branch is just a label for a specific commit, how does the `main` branch know to "follow" our `HEAD` from commit to commit?

It does it like this: the branch that `HEAD` points to follows the current commit. That is, when you make a commit, the branch `HEAD` points to moves along to that next commit.

If we were here back at Figure 5.7, when `HEAD` was pointing to the `main` branch, we could make one more commit and get us to Figure 5.9.

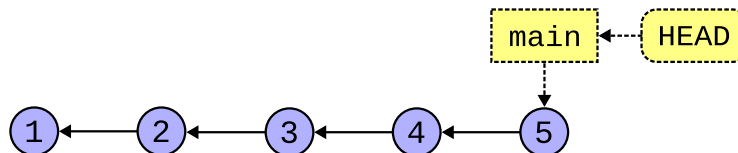

Figure 5.9: `HEAD` moving with a branch.

Contrast that to detached head state, back in Figure 5.8. If we were there, a new commit would get us to Figure 5.10, leaving `main` alone.

At this point, there's nothing stopping you from creating a new branch at the same commit as `HEAD`, if you want to do that. Or maybe you are just messing around and decide to switch back to `main` later, abandoning the commits you've made in detached `HEAD` state.

Now that we have the abstract theory stuff laid out, let's talk specifics.

5.4 Listing All Your Branches

Before we start, let's see how to list branches.

```
$ git branch
* main
```

This is telling you there's one branch, and you have it checked out (the `*` lets you know that).

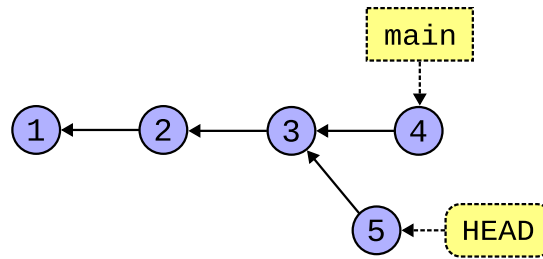

Figure 5.10: A commit with detached HEAD.

If I make a new branch called `foobran` and switch to that, I'll see this:

```
% git branch
* foobran
  main
```

If I then detach the HEAD, I end up here:

```
% git branch
* (HEAD detached at 10b6242)
  foobran
  main
```

But you can always see what branch you're on with `git branch` or `git status`.

5.5 Creating a Branch

When you make the first commit to a new repo, the `main` branch is automatically created for you at that commit.

But what about new branches we want to make?

Why make a branch? A common case is that you want to work on your own commits without impacting the work of others. (In this case you're really just putting off the work until you merge your branch with theirs, but it's a good workflow.)

Another case is that you want to mess around with some changes but you're not sure if they'll work. If they end up not working, you can just delete the branch. If they do work, you can merge your changes back into the non-messing-around branch.

The most common way to make new branches is this:

1. Switch to the commit or branch from which you want to make the new branch.
2. Make the new branch there and switch HEAD to point to the new branch.

Let's try it. Let's branch off `main`.

You might already have `main` checked out (i.e. HEAD points to `main`), but let's do it again to be safe, and then we'll create a branch with `git switch`:

```
$ git switch main
$ git switch -c newbranch
```

Normally you can just switch to another branch (i.e. have HEAD point to that branch) with `git switch branchname`. But if the branch doesn't exist, you need to use the `-c` switch to create the branch before switching to it.

Make sure all your local changes are committed before switching branches! If you `git status` it should say “working tree clean” before you switch. Later we'll learn about another option when we talk about stashing.

So after checking out `main`, we have Figure 5.11.

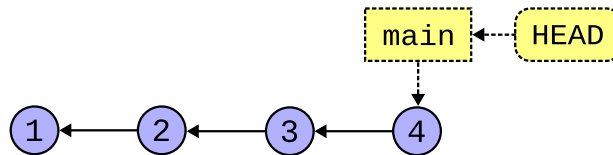

Figure 5.11: HEAD pointing to `main`.

And then with `git switch -c newbranch`, we create and switch to `newbranch`, and that gets us to Figure 5.12.

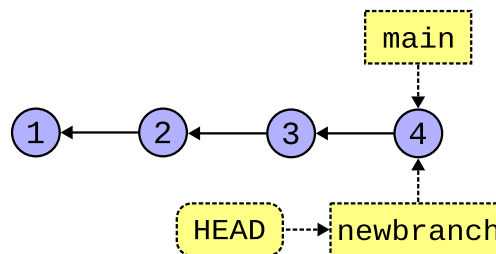

Figure 5.12: HEAD pointing to `newbranch`.

That's not super exciting, since we're still looking at the same commit, but let's see what happens when we make some new commits on this new branch.

The branches we're making here exist only on your local clone; they're not automatically propagated back to wherever you cloned the repo from.

The upshot is that if you accidentally (or deliberately) delete your local repo, when you `git clone` again, all your local branches will be gone (along with any commits that aren't part of `main` or any other branches pushed to the server).

There is a way to set up that connection where your local branches are uploaded when you push, called *remote-tracking branches*. `main` is connected to a remote tracking branch (usually called `origin/main`) which is why `git push` from `main` works while `git push` from `newbranch`, which is not by default connected to a remote tracking branch, gives an error. But we'll talk about all this later.

5.6 Make Some Commits on a Branch

This is not really that different than what we were doing with our commits before. Before we made a branch, we had HEAD pointing to branch `main`, and we were making commits on `main`.

Now we have HEAD pointing to `newbranch` and our commits will go there, instead.

Right after creating `newbranch`, we had the situation in Figure 5.12. Now let's edit something in the working tree and make a new commit. With that, we'll have the scenario in Figure 5.13.

Right? Let's make another commit and get to Figure 5.14.

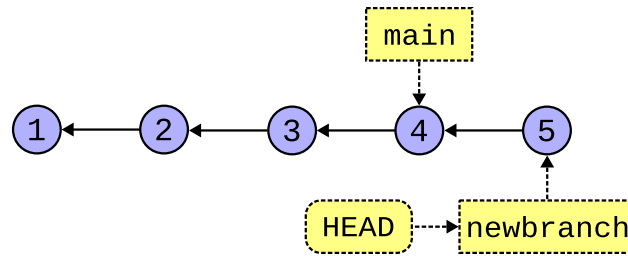
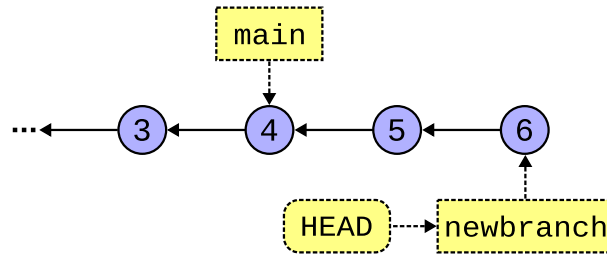
Figure 5.13: Adding a new commit to `newbranch`.Figure 5.14: Adding another commit to `newbranch`.

We can see that `newbranch` and `main` are pointing at different commits.

If we wanted to see the state of the repo from `main`'s perspective, what would we have to do?
We'd have to `git switch main` to look at that branch.

Now for another question. Let's say we've decided that we're happy with the changes on `newbranch`, and we want to merge them into the code in the `main` branch. How would we do that?

5.7 Merging: Fast-Forward

Bringing two branches back into sync is called *merging*.

The branch you're on is the branch you're bringing other changes *into*. That is, if you're on Branch A, and you tell git to "merge Branch B", Branch B's changes will be applied onto Branch A. (Branch B remains unchanged in this scenario.)

But in this section we're going to be talking about a specific kind of merge: the *fast-forward*. This occurs when the branch you're merging from is a direct descendant of the branch you're merging into.

Let's say we have `newbranch` checked out, like from the previous example in Figure 5.14.

I decide I want to merge `main`'s changes into `newbranch`, so (again, with `newbranch` currently checked out):

```
$ git merge main
Already up to date.
```

Nothing happened? What's that mean? Well, if we look at the commit graph, above, all of `main`'s changes are already in `newbranch`, since `newbranch` is a direct ancestor.

Git is saying, "Hey, you already have all the commits up to `main` in your branch, so there's nothing for me to do."

But let's reverse it. Let's check out `main` and then merge `newbranch` into it.

```
$ git switch main
```

Now we’ve moved `HEAD` to track `main`, as shown in Figure 5.15.

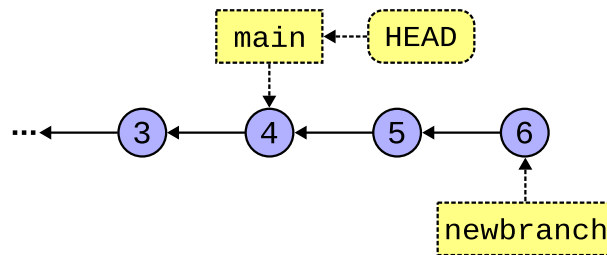

Figure 5.15: Checking out `main` again.

And `newbranch` is **not** a direct ancestor of `main` (it’s a descendant). So `newbranch`’s changes are **not** yet in `main`.

So let’s merge them in and see what happens (your output may vary depending on what files are included in the merge):

```
$ git merge newbranch
Updating 087a53d..cef68a8
Fast-forward
 foo.py | 4 +++-
 1 file changed, 3 insertions(+), 1 deletion(-)
```

And now we’re at Figure 5.16.

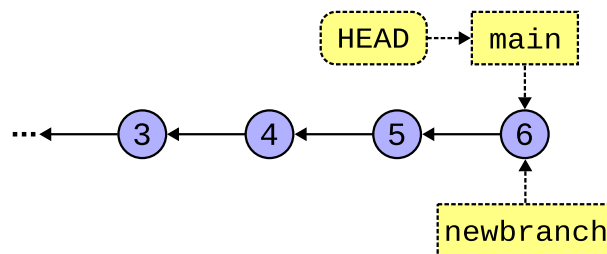

Figure 5.16: After merging `newbranch` into `main`.

Wait a second—didn’t we say to merge `newbranch` into `main`, like take those changes and fold them into the `main` branch? Why did `main` move, then?

We did say that! But let’s stop and think about how this can happen in the special case where the branch you’re merging *into* is a direct ancestor of the branch you’re merging *from*.

It used to be that `main` didn’t have commits (5) or (6) in the graph, above. But `newbranch` has already done the work of adding (5) and (6)!

The easiest way to get those commits “into” `main` is to simply *fast-forward* `main` up to `newbranch`’s commit!

Again, this only works when the branch you’re merging into is a direct ancestor of the branch you’re merging from.

That said, you certainly can merge branches that are not directly related like that, e.g. branches that share a common ancestor but have both since diverged.

Git will automatically fast-forward if it can. Otherwise it does a “real” merge. And while fast-forward merges can never lead to *merge conflicts*, regular merges certainly can.

But that’s another story we’ll get into in the Merging and Conflicts chapter.

5.8 Deleting a Branch

If you’re done merging your branch, it’s easy to delete it. **Importantly, this doesn’t delete any commits; it just deletes the branch “label” so you can’t use it any longer.** You can still use all the commits.

Let’s say we’ve finished the work on our `topic1` branch and we want to merge it into `main`. No problem:

```
$ git commit -m "finished with topic1" # on topic1 branch
$ git switch main
$ git merge topic1 # merge topic1 into main
```

At this point, assuming a completed merge, we can delete the `topic1` branch:

```
$ git branch -d topic1
Deleted branch topic1 (was 3be2ad2).
```

Done!

A *topic* branch is what we call a local branch made for a single topic like a feature, bug fix, etc. In this guide I’ll name branches literally `topic` to indicate that it’s just an arbitrary branch. But in real life you’d name the topic branch after what it is you’re doing, like `bugfix37`, `newfeature`, `experiment`, etc.

But what if you were working on a branch and wanted to abandon it before you merge it into something? For that, we have the more imperative Capital D option, which means, “I *really* mean it. Delete this unmerged branch!”

```
$ git branch -D topic1
```

Use lowercase `-d` unless you have reason to do otherwise. It’ll at least tell you if you’re about to lose your reference to your unmerged commits, and then you can override with `-D` if you really want to.

Chapter 6

Merging and Conflicts

We've seen how a fast-forward merge can bring branches into sync with no possibility of conflict.

But what if we can't fast-forward because two branches are not direct ancestors? In other words, what if the branches have *diverged*? What if a change in one branch *conflicts* with a change in the other?

6.1 An Example of Divergent Branches

Let's look at a commit graph where things are still OK to fast-forward in Figure 6.1.

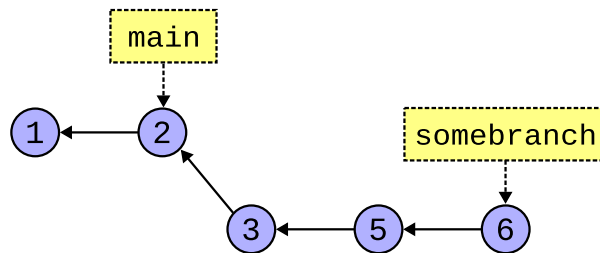

Figure 6.1: A direct ancestor branch.

Yes, I've bent the graph a bit there, but we can merge `somebranch` into `main` as a fast-forward because `main` is a direct ancestor and `somebranch` is therefore a direct descendant.

But what if, **before** we merged, someone made another commit on the `main` branch? And now it looks like it does in Figure 6.2.

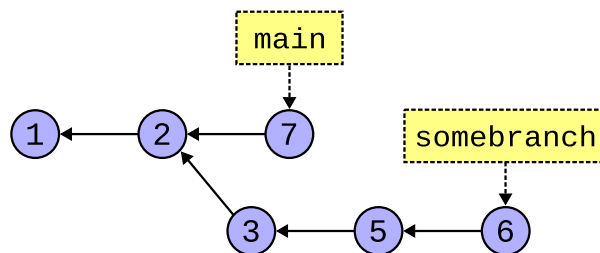

Figure 6.2: Not a direct ancestor branch.

There's a common ancestor at commit (2), but there's no direct line of descent. `main` and `somebranch` have diverged.

Is all hope lost? How can we merge?

6.2 Merging Divergent Branches

Turns out you do it the exact same way as always.

1. Check out the branch you want to merge *into*.
2. `git merge` the branch you want to merge *from*.

In our Figure 6.2 example above, let's say we've done this:

```
$ git switch main
$ git merge somebranch # into main
```

| The `#` is a shell comment delimiter. You can paste that in if you want, but it does nothing. |

The difference here is that Git can't simply fast-forward. It has to somehow, magically, bring together the changes from commit (6) **and** commit (7) even if they're radically different than one other.

This means that after we bring those two commits together, the code will look like it's never looked before, a combination of two sets of changes.

And because it looks like it hasn't before, we need *another commit* (another snapshot of the working tree) to represent the joining of both sets of changes.

We call this the *merge commit*, and Git will automatically make it for you. (When this happens, you'll see an editor pop up with some text in it. This text is the commit message. Edit it (or just accept it as-is) and save the file and exit the editor. See Getting Out of Editors if you need help with this.)

So after our merge, we end up with Figure 6.3.

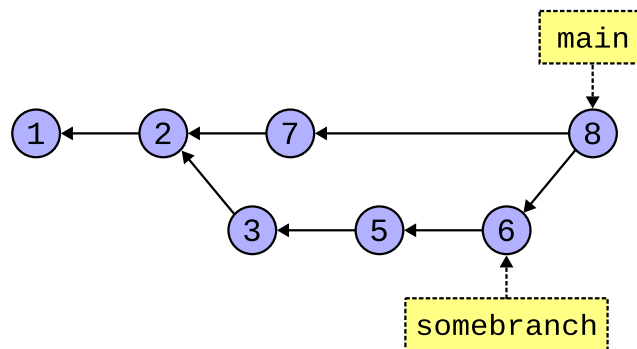

Figure 6.3: Creating a merge commit.

Commit labeled (8) is the merge commit. It contains both the changes from (7) and (6). And has the commit message you saved in the editor.

And we see `main` has been updated to point to it. And that `somebranch` is unaffected.

Importantly, we see that commit (8) has **two parents**, the commits that were merged together to make it.

And look! If we want, we can now fast-forward `somebranch` to `main` because it's now a direct ancestor!

In this example, Git was able to determine how to do the merge automatically. But there are some cases where it cannot, and this results in a *merge conflict* that requires manual intervention. By you.

6.3 Merge Conflicts

If two branches have changes that are “far apart” from one another, Git can figure it out. If I edit line 20 of a file in one branch, and you edit line 3490 of the same file in another, Git can bring both edits in automatically.

But let’s say I edit line 20 in one commit, and you edit line 20 (the same line) in another commit.

Which one is “right”? Git has no idea because it’s just dumb software and doesn’t know our business needs.

So it asks us, during the merge, to fix it. After we fix it, Git can complete the merge.

When you’re merging, if a conflict occurs, you’re still merging. Git is in the “merge” state, waiting for more merge-specific commands.

You can resolve the conflict then commit the changes to complete the merge. Or you can back out of the merge making as if you’d never started it in the first place.

The important point is that you’re aware Git is in a special state and you have to either complete or abort the merge to get back to normal before you continue to use it.

Let’s have an example where both `main` and `newbranch` have added a line to end of file, i.e. they both added line 4. Git doesn’t know which one is correct, so there’s a conflict.

```
$ git merge newbranch
Auto-merging foo.py
CONFLICT (content): Merge conflict in foo.py
Automatic merge failed; fix conflicts and then commit the result.
```

Now if I look at my status, I see we’re in merge state, as noted by `You have unmerged paths`. We’re in the middle of merge; we have to either go out the front or back out the back to get back to normal.

```
$ git status
On branch main
You have unmerged paths.
  (fix conflicts and run "git commit")
  (use "git merge --abort" to abort the merge)

Unmerged paths:
  (use "git add <file>..." to mark resolution)
   both modified:   foo.py

no changes added to commit (use "git add" and/or "git commit -a")
```

It’s also hinting that I can do one of two things:

1. Fix conflicts and run `git commit`.
2. Use `git merge --abort` to abort the merge.

The second just rolls back the merge making it as if I hadn’t run `git merge` in the first place.

So let’s focus on the first. What are these conflicts and how do I resolve them?

6.4 What a Conflict Looks Like

My error message above is telling me that `foo.py` has unmerged paths. So look at what’s happened with that file.

Before I started any of this, the file `foo.py` only had this in it on branch `main`:

```
print("Commit 1")
```

And I added a line so it looked like this:

```
print("Commit 1")
print("Commit 4")
```

And committed it.

But what I didn't realize was that my teammate had also made another commit on `newbranch` that added different lines to the bottom of the file.

So when I went to merge `newbranch` into `main`, I got this conflict. Git doesn't know which additional lines are correct.

Here's where the fun begins. Let's edit `foo.py` here in the middle of the merge and see what it looks like:

```
print("Commit 1")
<<<<<<< HEAD
print("Commit 4")
=====
print("Commit 2")
print("Commit 3")
>>>>>> newbranch
```

What the giblets is all that? Git has totally screwed with the contents of my file!

Yes, it has! But not for no reason; let's examine what's in there.

We have three delimiters: `<<<<<<`, `=====`, and `>>>>>>`.

Everything from the top delimiter to the middle one is what's in `HEAD` (the branch you're on and merging into).

Everything from the middle delimiter to the bottom one is what's in `newbranch` (the branch you're merging from).

So Git has "helpfully" given us the information we need to make a semi-informed decision about what to do.

And here's exactly the steps we must follow:

1. Edit the conflicting file(s), remove all those extra lines, and **make the file(s) Right**.
2. Do a `git add` to add the file(s).
3. Do a `git commit` to finalize the merge.

Now, when I say "make the file *Right*", what does that mean? It means that I need to have a chat with my teammate and figure out what this code is supposed to do. We clearly have different ideas, and only one of them is right.

So we have a chat and hash it out. We finally decide the file should look like this:

```
print("Commit 1")
print("Commit 4")
print("Commit 3")
```

And then I (since I'm the one doing the merge), edit `foo.py` and remove all the merge delimiters and everything else, and make it look exactly like we agreed upon. I make it look *Right*.

Then I add the file to the stage:

```
$ git add foo.py
$ git status
On branch main
All conflicts fixed but you are still merging.
(use "git commit" to conclude merge)

Changes to be committed:
  modified:   foo.py
```

Notice that `git status` is telling me we're still in the merging state, but I've resolved the conflicts. It tells me to `git commit` to finish the merge.

What if I added the conflict file too soon? For example, what if you add it but then you realize there are still unresolved conflicts or the file isn't *Right*? If you haven't committed yet, you have a couple options. (If you have committed, all you can do is reset or revert.)

One option is to just edit the file again, and re-add it when it's done. (After editing the file will show up as a "change not staged for commit" until you add it again.)

Another option is to move the file off the stage with `git checkout --merge` on the file to get it back to the "both modified" state. Helpfully, this won't delete the changes you already added. This is especially useful if you're using a merge tool.

So now that we've added the file, let's make the merge commit. Here we're manually making the merge commit, unlike above where Git was able to automatically make it.

```
$ git commit -m "Merged with newbranch"
[main 668b506] Merged with newbranch
```

And that's it! Let's check status just to be sure:

```
$ git status
On branch main
nothing to commit, working tree clean
```

Success!

Just to wrap up, let's take a look at the log at this point:

```
$ git log
commit 668b5065aa803fa496951b70159474e164d4d3d2 (HEAD -> main)
Merge: e4b69af 81d6f58
Author: User Name <user@example.com>
Date: Sun Feb 4 13:18:09 2024 -0800

    Merged with newbranch

commit e4b69af05724dc4ef37594e06d0fd323ca1b8578
Author: User Name <user@example.com>
Date: Sun Feb 4 13:16:32 2024 -0800

    Commit 4

commit 81d6f58b5982d39a1d92af06b812777dbb452879 (newbranch)
```

```
Author: User Name <user@example.com>
Date:   Sun Feb 4 13:16:32 2024 -0800

    Commit 3

commit 3ab961073374ec26734c933503a8aa988c94185b
Author: User Name <user@example.com>
Date:   Sun Feb 4 13:16:32 2024 -0800

    Commit 1
```

We see a few things. One is that our merge commit is pointed to by `main` (and `HEAD`). And looking down a couple commits, we see our now-direct ancestor, `newbranch` back on Commit 3.

We also see a `Merge:` line on that top commit. It lists the commit hashes for the two commits that it came from (the first 7 digits, anyway), since the merge commit has two parents.

6.5 Why Merge Conflicts Happen

Generally, it's because you haven't coordinated with your team about who is responsible for which pieces of code. Generally two people shouldn't be editing the same lines of code in the same file at once.

That said, there are absolutely cases where it does happen and is expected. The key is to communicate with your team when resolving the conflict if you don't know what is *Right*.

6.6 Merging with IDEs or other Merge Tools

IDEs like VS Code might have a special merge mode where you can choose one set of changes or another, or both. Likely "both" is what you want, but make an informed decision on the matter.

Also, even when selecting "both", it could be that the editor puts them in the wrong order. It's up to you to make sure the file is *Right* before making the final commit to complete the merge.

You can do this by, after the tool has been used to resolve the conflict, opening the file again in a new window and making sure it's as you want it, and editing it to be if it's not.

For more information about merge tools, see the Mergetool chapter.

6.7 Merge Big Ideas

DON'T PANIC! If you have a merge conflict, you can totally work it out. They're a common occurrence, and the more of them you do, the better at them you get.

Nothing to worry about. Everything is in Git's commit history, so even if you botch it, you can always get things back the way they were.

Chapter 7

Using Subdirectories with Git

This is a shorter chapter, but we want to talk about Git’s behavior when it comes to working in subdirectories and some gotchas that you probably don’t want to get wrapped up in.

7.1 Repos and Subdirectories

When you run a `git` command, Git looks for a special directory called `.git` (“dot git”) in the current directory. As we’ve already mentioned, this is the directory, created when you create the repo, that holds the metadata about the repo.

But what if you’re in a subdirectory in your project, and there’s no `.git` directory there?

Git starts by looking in the current directory for `.git`. If it can’t find it there, it looks in the parent directory. And if it’s not there, it looks in the grandparent, etc., all the way back to the root directory.

7.1.1 What about Subprojects?

One common student question is, “Should I make one single repo for CS101 with subdirectories for each project? Or should I make a different repo for every project?”

Firstly, see if your instructor has a requirement or preference, but other than that, it doesn’t technically matter which approach you use.

In real life, bigger repos (much bigger than you’ll typically be using for a class) take a lot longer to clone due to their size.

What happens if you initialize a new Git repo *inside* an existing repo? It’s not great. Don’t do this.

For mixing and matching different repos in the same hierarchy, Git has the concept of submodules, and you can find more information in the Submodules chapter. If you’re in school, submodules are typically not used.

7.2 Accidentally Making a Repo in your Home Directory

Git won’t stop you from making a repo in your home directory, i.e. a repo that contains everything in all your directories.

But that’s probably not what you wanted to do.

How does one make this mistake? Usually it’s with `git init .` in your home directory. You can also make this error by launching VS Code from your home directory and telling it to “Initialize Repository” in that location.

This is particularly insidious because if you're in a subdirectory that you *think* is a standalone repo, you might have been misled since Git searches parent folder for the `.git` directory and it could be finding the spurious one you accidentally made in your home directory.

We¹ recommend against one big repo from your home directory. You should have separate subdirectories for each of your repos.

If you accidentally create a repo where you didn't want to, changing a Git repo to a regular subdirectory is as simple as removing the `.git` directory. Be careful that you're removing the correct one when you do this!

One hack you can do to prevent Git from creating a repo in your home directory is to preemptively put an unwriteable `.git` directory there.

```
$ mkdir ~/.git      # Make the .git directory
$ chmod 000 ~/.git  # Take away all permissions
```

This way when Git tries to make its metadata folder there, it'll be stopped because you don't have write permission to that `.git` directory.

(You can always delete this directory with `rmdir` even if you don't have write permission to it.)

7.3 Empty Subdirectories in Repos

Turns out Git doesn't support this. It only tracks files, so if you want a subdirectory represented in your repo, you must have at least one file in it.

A common thing to do is add an empty file called `.gitkeep` ("dot git keep") to the subdirectory, then add it to the repo. This will cause Git to recreate the subdirectory when it clones or merges the `.gitkeep` directory.

The file `.gitkeep` isn't special in any way, other than convention. The file could be called anything. For example, if you know you'll need to eventually put a `.gitignore` in that directory, you might just use that instead. Or a `README`.

¹All Git enthusiasts collectively, that is.

Chapter 8

Ignoring Files with `.gitignore`

What if you have files in your subdirectory you don't want Git to pay any attention to? Like maybe you have some temporary files you don't want to see in the repo. Or maybe you have an executable you built from a C project and you don't want that checked in because your incredibly strict instructor won't grade your project if the repo contains any build products? For example.

That's what this part of the guide is all about.

8.1 Adding a `.gitignore` File

In any directory of a Git repository, you can add a `.gitignore` ("dot gitignore") file.

This is a simple textfile that contains a list of file names to ignore.

Let's say I have a C project that builds an executable called "doom". I wouldn't want to check that into my source repo because it's not source, and it's just a big binary that takes a bunch of disk.

But when I get the status, it's annoying to see Git complaining about it:

```
$ git status
On branch main
Untracked files:
  (use "git add <file>..." to include in what will be committed)
  doom

nothing added to commit but untracked files present (use "git
add" to track)
```

So I edit a `.gitignore` file in that directory and add this one line to it:

```
doom
```

Now I run status again:

```
$ git status
On branch main
Untracked files:
  (use "git add <file>..." to include in what will be committed)
```

```
.gitignore

nothing added to commit but untracked files present (use "git
add" to track)
```

What? Same thing? Not quite! Read the fine print!

It used to be complaining that `doom` was untracked, but now it's not complaining. So the `.gitignore` worked. Woo hoo!

But Git has found another untracked file in the brand new `.gitignore`. So we should add that to the repo.

Always put your `.gitignore` files in the repo unless you have a compelling reason not to. This way they'll exist in all your clones, which is handy.

```
$ git add .gitignore
$ git commit -m Added
[main 07582ad] Added
 1 file changed, 1 insertion(+)
 create mode 100644 .gitignore
```

Now we get the status:

```
$ git status
On branch main
nothing to commit, working tree clean
```

and we're all clear. That `doom` file is still there in the working tree, but Git pays it no heed since it's in the `.gitignore`.

8.2 Can I Specify Subdirectories in `.gitignore`?

Yes!

You can be as specific or as non-specific as you like with file matches.

Here's a `.gitignore` looking for a very specific file:

```
subdir/subdir2/foo.txt
```

That will match anywhere in the repo. If you want to only match a specific file from the repo root, you can prepend a slash:

```
/subdir/subdir2/foo.txt
```

Note that means `subdir` in the root of the *repo*, not the root directory of your entire filesystem.

If you put this in your `.gitignore`:

```
foo.txt
```

it will ignore `foo.txt` in all subdirectories of the repo.

8.3 Where do I Put the `.gitignore`?

You can add `.gitignore` files to any subdirectories of your repo. But how they behave depends on where they are.

The rule is this: *each `.gitignore` file applies to its containing directory **and** all the subdirectories below it.*

So if you put a `.gitignore` in your repo's root directory that has `foo.txt` in it, every single `foo.txt` in every subdirectory of your repo will be ignored.

Use the highest-level `.gitignore` file to block things you know you don't want **anywhere** in your repo.

If you add additional `.gitignore` files to subdirectories, those only apply to that subdirectory and below.

The idea is that you start with the most broadly applicable set of ignored files in your repo root, and then get more specific in the subdirectories.

For simple repos, you're fine just having one `.gitignore` in the repo root directory.

And we'll also talk about overriding `.gitignore` entries soon.

8.4 Wildcards

Do I have to individually list all the files I don't want in the `.gitignore`? What a pain!

Luckily Git supports *wildcards* in ignored file naming.

For example, if we wanted to block all the files that ended with a `.tmp` or `.swp` (Vim's temp file name) extension, we could use the `*` ("splat") wildcard for that. Let's make a `.gitignore` that blocks those:

```
*.tmp
*.swp
```

And now any files ending with `.tmp` or `.swp` will be ignored.

Turns out that Vim has two kinds of swap files, `.swp` and `.swo`. So could we add them like this?

```
*.tmp
*.swo
*.swp
```

Sure! That works, but there's a shorter way where you can tell Git to match any character in a bracketed set. This is equivalent to the above:

```
*.tmp
*.sw[op]
```

You can read that last line as, "Match file names that begins with any sequence of characters, followed by `.sw`, followed by either `o` or `p`."

8.5 Negated `.gitignore` Rules

What if your root `.gitignore` is ignoring `*.tmp` files for the entire repo. No problem.

But then later in development you have some deeply nested subdirectory that has a file `needed.tmp` that you really need to get into Git.

Bad news, though, since `*.tmp` is ignored at the root level across all subdirectories in the repo! Can we fix it?

Yes! You can add a new `.gitignore` to the subdirectory with `needed.tmp` in it, with these contents:

```
!needed.tmp
```

This tells Git, “Hey, if you were ignoring `needed.tmp` because of some higher-up ignore rule, please stop ignoring it.”

So while `needed.tmp` was being ignored because of the root level ignore file, this more-specific file overrides that.

If you needed to allow all `.tmp` files in this subdirectory, you could use wildcards:

```
!*.tmp
```

And that would make it so all `.tmp` files in this subdirectory were not ignored

8.6 How To Ignore All Files Except a Few?

You can use the negated rules for that.

Here’s a `.gitignore` that ignores everything except files called `*.c` or `Makefile`:

```
*  
!*.c  
!Makefile
```

The first line ignores everything. The next two lines negate that rule for those specific files.

8.7 Getting Premade `.gitignore` Files

Here’s a repo¹ with a whole bunch.

But you can also roll your own as needed. Use `git status` often to see if any files are there you want to ignore.

When you create a new repo on GitHub, it also gives you the option to choose a prepopulated `.gitignore`. **Warning!** Only do this if you’re not planning to push an already-existing repo into this newly-made GitHub repo. If you plan to do this, GitHub’s `.gitignore` will get in the way.

¹<https://github.com/github/gitignore>

Chapter 9

Remotes: Repos in Other Places

A *remote* is just a name for a remote server you can clone, push, and pull from.

We identify these by a URL. With GitHub, this is a URL we copied when we went to clone the repo initially.

It's possible to use this URL to identify the server in our everyday Git usage, but it's unwieldy to type. So we give the remote server URLs nicknames that we just tend to call "remotes".

A remote we've already seen a bunch of is `origin`. This is the nickname for the remote repo you cloned from, and it gets set automatically by Git when you clone.

9.1 Remote and Branch Notation

Before we begin, note that Git uses slash notation to refer to a specific branch on a specific remote: `remotename/branchname`.

For example, this refers to the `main` branch on the remote named `origin`:

```
origin/main
```

And this refers to the branch named `feature3490` on a remote named `nitfol`:

```
nitfol/feature3490
```

We'll talk more about this in the Remote Tracking Branches chapter.

9.2 Getting a List of Remotes

You can run `git remote` with the `-v` option in any repo directory to see what remotes you have for that repo:

```
$ git remote -v
origin    https://github.com/example-repo.git (fetch)
origin    https://github.com/example-repo.git (push)
```

We see that we're using the same URL for the remote named `origin` for both pull (part of which is `fetch`) and push. Having the same URL for both is super common.

And that URL is the exact same one we copied from GitHub when cloning the repo in the first place.

9.3 Changing a Remote's URL

Remember that a remote name is just an alias for some URL that you cloned the repo from.

Let's say that you are all set up with your SSH keys to use GitHub for both push and pull, but you accidentally cloned the repo using the HTTPS URL. In that case, you'll see the following remote:

```
$ git remote -v
origin    https://github.com/example-repo.git (fetch)
origin    https://github.com/example-repo.git (push)
```

And then you try to push, and GitHub tells you that you can't push to an HTTPS remote... dang it!

You meant to copy the SSH URL when you cloned, which for me looks like:

```
git@github.com:beejjorgensen/git-example-repo.git
```

Luckily it's not the end of the world. We can just change what the alias points to.

(The example below is split into two lines so that it's not too wide for the book, but it can be on a single line. The backslash lets Bash know that the line continues.)

```
$ git remote set-url origin \
    git@github.com:beejjorgensen/git-example-repo.git
```

And now when we look at our remotes, we see:

```
$ git remote -v
origin    git@github.com:beejjorgensen/git-example-repo.git (fetch)
origin    git@github.com:beejjorgensen/git-example-repo.git (push)
```

And now we can push! (Assuming we have our SSH keys set up.)

9.4 Adding a Remote

There's nothing stopping you from adding another remote.

A common example is if you *forked* a GitHub Project (more on that later). A fork is a GitHub construct that enables you to easily clone someone else's public repo into your own account, and gives you a handy way to share changes you make with the original repo.

Let's say I forked the Linux source repo. When I clone my fork, I'll see these remotes:

```
origin    git@github.com:beejjorgensen/linux.git (fetch)
origin    git@github.com:beejjorgensen/linux.git (push)
```

I don't have access to the real Linux source code, but I can fork it and get my own copy of the repo.

Now, if Linus Torvalds makes changes to his repo, I won't automatically see them. So I'd like some way to get his changes and merge them in with my repo.

I need some way to refer to his repo, so I'm going to add a remote called `reallinux` that points to it:

```
$ git remote add reallinux https://github.com/torvalds/linux.git
```

Now my remotes look like this:

```
origin    git@github.com:beejorgensen/linux.git (fetch)
origin    git@github.com:beejorgensen/linux.git (push)
reallinux https://github.com/torvalds/linux.git (fetch)
reallinux https://github.com/torvalds/linux.git (push)
```

Normally when setting up a remote that refers to the source of a forked repo on GitHub, people tend to call that remote `upstream`, whereas I've clearly called it `reallinux`.

I did this because when we subsequently talk about remote tracking branches, we're going to use "upstream" to mean something else, and I don't want the two to be confusing.

Just remember IRL when you set up a remote to point to the forked-from repo, it's relatively customary to call that remote `upstream`.

Now I can run this to get all the changes from Linus's repo:

```
$ git fetch reallinux
```

And I can merge it into my branch (the Linux repo uses `master` for the instead of `main` for the main branch):

```
$ git switch master          # My local master
$ git merge reallinux/master # Note the slash notation!
```

That will merge the `master` branch from the `reallinux` into my local `master`, once we've dealt with any conflicts.

If I make another commit, this will move my local `HEAD` and `master` to that new commit, and will leave `origin/master` (my fork on GitHub) and `reallinux/master` (Linus's repo) farther behind.

Let's say for fun I made two commits that I didn't have on my `origin` remote at GitHub. In that case, a chopped up and fabricated-for-demonstration-purposes log might look like this:

```
commit 2d7d5d (HEAD -> master)
commit cde831
commit 311eb3 (origin/master)
commit d5d2cc (reallinux/master)
```

At this point I'd do a `git push` to send my local `master` changes to GitHub and catch up my `origin/master` there. So the top commit would show:

```
commit 2d7d5d (HEAD -> master, origin/master)
commit cde831
commit 311eb3
commit d5d2cc (reallinux/master)
```

And `reallinux/master` would still be behind somewhere. (And there it would remain until Linus deigned to merge my changes.)

It's interesting that my local `master` can be out of sync from the `master` on `origin`, right?

We'll look at this in the Remote Tracking Branches chapter.

Chapter 10

Remote Tracking Branches

We've seen how to create local branches that you do work on, then merge back into the `main` branch, then `git push` it up to a remote server.

This part of the guide is going to try to clarify what's actually going on behind the scenes, as well as give us a way to push our local branches to a remote for safe keeping.

10.1 Branches on Remotes

First, some refresher!

Recall that the remote repo you cloned yours from is a complete copy of your repo. The remote repo has a `main` branch, and therefore your clone also has a `main` branch.

That's right! When you make a GitHub repo and then clone it, there are **two** `main` branches!

How do we differentiate them?

Well, on your local clone, we just refer to branches by their plain name. When we say `main` or `topic2`, we mean the local branch by that name on our repo.

If we want to talk about a branch on a remote, we have to give the remote name along with the branch using that slash notation we've already seen:

```
main          # main branch on your local repo
origin/main   # main branch on the remote named origin
upstream/main # main branch on the remote named upstream
zork/mailbox  # mailbox branch on the remote named zork
mailbox       # mailbox branch on your local repo
```

Importantly, not only do the words `origin/main` refer to the `main` branch on `origin` in casual conversation, but you actually have a branch on your local repo called `origin/main`.

This is called a *remote-tracking branch*. It's your local copy of the `main` branch on the remote. You can't move your local `origin/main` branch directly; Git does it for you as a matter of course when you interact with the remote (e.g. when you push or pull).

We're going to call the `main` branch on our local machines the *local branch*, and we'll call the one on `origin` the *upstream branch*.

And this is going to get confusing later when we name a remote `upstream` in a way that has nothing to do with the *upstream branch* terminology we’re using here.

I want to go over that one more time to drive it home.

Let’s say you have these two branches on your computer because you’ve just cloned the remote repo at the `origin`:

```
main          # main branch on your local repo
origin/main   # main branch on the remote named origin
```

When you have those two branches on your computer, *there are actually three branches in the world*.

1. `main` on your computer.
2. `origin/main` on your computer.
3. `main` on the `origin` computer, usually a different computer than yours, e.g. one at GitHub or something.

Notice that the first two of these are on the repo on your computer!

The branch `origin/main` is just where your computer *thinks* that `main` on the `origin` is. Your computer got this information the last time you pulled or fetched from `origin`.

If other people have pushed to `main` on `origin` since your last pull, your `origin/main` on your local computer won’t be up to date.

And normally you don’t have to worry about this much; when you try to push, Git will tell you if someone else has pushed changes in the meantime and you have to pull first to update your `origin/main` branch. No biggie.

But I wanted to spell that out so you had a more complete mental model of what’s happening behind the curtain, here.

10.2 Listing Remote Tracking Branches

Remember how `git branch` listed the branches you had? Let’s power it up so you can see all the remote tracking branches, as well. This will help in the following sections.

Basically, we just give it the `-avv` switch for “all” (to list the remote tracking branches) and “verbose” (to give info about which commits they’re pointing to) and “verbose” again (to give info about which remote branches map to which remote branches).

Here’s the result for the repo that holds the source for this book:

```
% git branch -avv
* main          2d63af5 [origin/main] indexing
  sphinx        cdac325 [origin/sphinx] partial port
remotes/origin/HEAD -> origin/main
remotes/origin/main 2d63af5 indexing
remotes/origin/sphinx cdac325 partial port
```

We see my two local branches (`main` and `sphinx`). Looking on those two top lines, you see remote tracking branches in brackets (`origin/main` and `origin/sphinx`). When I push or pull from `main` or `sphinx`, those are the remote tracking branches that are merged to.

Additionally, we see information about the remote below that.

The first line about `remotes/origin/HEAD` is a little strange. It just points to `origin/main` which simply lets us know that `main` is the initial branch for the repo that Git will use when you clone it. You typically don't need to think about this line.

The remaining two lines tell us what commits the remote tracking branches `origin/main` and `origin/sphinx` are pointing at. Looking closely, we see they're pointing to the same commits as our local `main` and `sphinx` indicating that everything is in sync. (As far as we know—someone else might have pushed something to the repo since our last pull and we don't know about that yet.)

10.3 Pushing to a Remote

Fun Fact: when you push or pull, you technically specify the remote and the branch you want to use. This is me saying, “Push the branch I'm on right now (presumably `main`) and merge it into `main` on `origin`.”

```
$ git push origin main
```

“But wait! I haven't been doing that!”

It turns out there's an option you can set to make it happen automatically. Let's say you're on the `main` branch and then run this:

```
$ git push --set-upstream origin main
$ git push -u origin main           # same thing, shorthand
```

This will do a couple things:

1. It'll push changes on your local `main` to the remote server (that's the `push origin main` part).
2. It'll remember that the remote branch `origin/main` is tracking your local `main` branch (that's the `-u` part).

And then, from then on, from the `main` branch, you can just:

```
$ git push
```

and it'll automatically push to `origin/main` thanks to your earlier usage of `--set-upstream`.

And `git pull` has the same option, as well, though you only need to do it once with either push or pull.

“But wait! I've never used `--set-upstream`, either!”

That's because by default when you clone a repo, Git automagically sets up a local branch to track the `main` branch on the remote.

Depending on how you made your repo, you might also have a reference to `origin/HEAD`. It might be weird to think that there's a `HEAD` ref on a remote server that you can see, but in this case it's just referring to the branch that you'll be checking out by default when you clone the repo.

“OK, so what you're telling me is that I can just `git push` and `git pull` like always and just ignore everything you wrote in this section?”

Well... yes. Ish. No. We're going to make use of this to push other branches to the remote!

10.4 Making a Branch and Pushing to Remote

I'm going to make a new local branch `topic99`:

```
$ git switch -c topic99
Switched to a new branch 'topic99'
```

And make some changes:

```
$ vim README.md          # Create and edit a README
$ git add README.md
$ git commit -m "Some important additions"
```

In our log, we can see where all the branches are:

```
commit 79ddba75b144bad89e1cbd862e5f3b3409f6c498 (HEAD -> topic99)
Author: User Name <user@example.com>
Date:   Fri Feb 16 16:44:50 2024 -0800

    Some important additions

commit 3be2ad2c31b627b431af8c8e592c01f4b989d621 (origin/main, main)
Author: User Name <user@example.com>
Date:   Fri Feb 16 16:14:13 2024 -0800

    Initial checkin
```

`HEAD` refers to `topic99`, and that's one commit ahead of `main` (local) and `main` (upstream on the `origin` remote), as far as we know. And we know this because it's one commit ahead of our remote-tracking branch `origin/main`.

Now let's push!

```
$ git push
fatal: The current branch topic99 has no upstream branch.
To push the current branch and set the remote as upstream, use

    git push --set-upstream origin topic99

To have this happen automatically for branches without a tracking
upstream, see 'push.autoSetupRemote' in 'git help config'.
```

Ouch. The short of all this is that we said “push”, and Git said, “To what? You haven't associated this branch with anything on the remote!”

And we haven't. There's no `origin/topic99` remote-tracking branch, and certainly no `topic99` branch on that remote. Yet.

The fix is easy enough—Git already told us what to do.

```
$ git push --set-upstream origin topic99
```

And that will do it.

At this point, assuming you've pushed to GitHub, you could go to your GitHub page for the project, and near the top left you should see something that looks like Figure 10.1.

If you pull down that `main` button, you'll see `topic99` there as well. You can select either branch and view it in the GitHub interface.



Figure 10.1: Two branches on GitHub

10.5 Deleting Remote Tracking Branches

There are few things that can happen here.

1. Someone deletes the branch on the remote, but your corresponding remote tracking branch (the one on your clone) still exists and you want to delete it.
2. You want to delete your remote tracking branch, and you want to leave the corresponding branch untouched on the remote.
3. You delete your remote tracking branch and you want to delete the corresponding branch on the remote, too.

For all of these, it's good to have your working tree clean, of course.

10.5.1 Fetching Deleted Remote Branches

The first one is pretty easy. Let's tell Git to delete all our remote tracking branches that no longer exist on the `origin` remote:

```
$ git fetch --prune
```

or if you want to specify a remote:

```
$ git fetch --prune someremote
```

or if you want to prune all remotes:

```
$ git fetch --prune --all
```

10.5.2 Deleting Your Remote Tracking Branch

In this case, you have a remote tracking branch on your clone that you want to delete. But you don't want to delete that branch from the server.

Use `-d` for delete and `-r` for remote:

```
$ git branch -dr remote/branch
```

For example:

```
$ git branch -dr origin/topic99
```

10.5.3 Deleting a Branch on a Remote

Finally, let's say you've deleted your remote tracking branch on your clone, as per above, and you also want to delete it on the remote.

We're going to (perhaps surprisingly) use `git push` for this.

To delete a branch on the remote, you:

```
$ git push someremote --delete branchname
```

For example:

```
$ git push origin --delete topic99
```

And that's it! Make sure you delete your remote tracking branch

10.6 Multiple Remotes

It's possible that you might have multiple remotes. (This is commonly put in place when you've forked someone's repo on GitHub.)

How do remote tracking branches work in that case?

Let's say your main remote is called `origin` as usual. But you've also set another remote called `remote2`, unoriginally.

Someone else pushes a new branch called `foobranh` (slightly more originally) up to `remote2` and you'd like to get it.

So you do this:

```
$ git fetch remote2
remote: Enumerating objects: 15, done.
remote: Counting objects: 100% (15/15), done.
remote: Compressing objects: 100% (4/4), done.
remote: Total 12 (delta 6), reused 11 (delta 5), pack-reused 0
Unpacking objects: 100% (12/12), 1.61 KiB | 34.00 KiB/s, done.
From github.com:user/somerepo
* [new branch]      foobranh -> remote2/foobranh
```

So far so good. Let's switch to it:

```
$ git switch foobranh
branch 'foobranh' set up to track 'remote2/foobranh'.
Switched to a new branch 'foobranh'
```

Wait! We're tracking at `remote2`? That's a little weird because it's the other person's repo. Maybe you have permission to write to it, and that's what you want to do. But it's more probably you'd like your own version of this branch on your repo as well.

You can do that by pushing it to your remote with `-u` again.

```
$ git push -u origin foobranh
```

And that'll do it.

If you look at your branches with `git branch -avv` you'll see now several `foobranh` variants for different clones.

```
foobranh
remotes/origin/foobranh
remotes/remote2/foobranh
```

If you want to keep your `origin/foobranh` in sync with that on `remote2`, you'll have to do a bunch of merging.

```
$ git fetch remote2          # Get remote2 changes
$ git switch foobranh       # Get onto the merge-into branch
$ git merge remote2/foobranh # Merge changes from remote2
$ git push origin foobranh   # Push changes back to origin
```

(You can leave the `origin foobranh` off the `push` if you've already pushed it with `-u` earlier, of course.)

At that point, every `foobranh` should be on the same commit.

Chapter 11

File States

We've talked about this quite a bit in passing already.

If you create a new file, you have to `git add` it to the stage before you commit.

If you modify a file, you should `git add` it to the stage before you commit.

If you add a file `foo.txt` to the stage, you can remove it from the stage before you commit with `git restore --staged foo.txt`.

So clearly files can exist in a variety of “states” and we can move them around between those states.

To figure out what state a file is in and get a hint on how to “undo” it from that state, `git status` is your best friend (except in the case of renaming, but more on that mess soon).

11.1 What States Can Files in Git Be In?

There are four of them: **Untracked**, **Unmodified**, **Modified**, and **Staged**.

- **Untracked:** Git does not know anything about this file (e.g. you just created it in the working tree and haven't added it). Git will ignore it, but you'll see it in the status.

You can make Git aware of this file by moving it to Staged State with `git add`.

Or you can simply remove the file if you don't want it to exist, or you can add it to your `.gitignore` if you want to leave it in place but still have Git ignore it.

- **Unmodified:** Git knows about this file and it's in the repo. But you haven't made any changes to it since it was last committed.

You can move this file to Modified State by making changes to the file (and saving).

You can remove this file with `git rm`, which changes the removed file to the Staged State. (Wait—removing the file puts it on the stage? Yes! More on that later.)

- **Modified:** Git knows about this file and knows that you've changed it. It's ready for you to stage those changes or to undo them.

You can change the file to Staged State with `git add`.

You can change the file to Unmodified State (throwing away your changes) with `git restore`.

- **Staged:** The file is ready to be included in the next commit.

You can change to Unmodified State by making a commit with `git commit`.

You can remove the file from the stage and back to Modified State with `git restore --staged`.

A file typically goes through this process to be added to a repo:

1. The user creates a new file and saves it. This file is **Untracked**.
2. The user adds the file with `git add`. The file is now **Staged**.
3. The user commits the file with `git commit`. The file is now **Unmodified** and is part of the repo and ready to go.

After it's in the repo, the typical file life cycle only differs by the first step:

1. The user changes the file and saves it. The file is now **Modified**.
2. The user adds the file with `git add`. The file is now **Staged**.
3. The user commits the file with `git commit`. The file is now **Unmodified** and is part of the repo and ready to go.

Keep in mind that often a commit is a bundle of different changes to different files. All those files would be added to the stage before the single commit.

Here's a partial list of ways to change state:

- **Untracked** → `git add foo.txt` → **Staged** (as "new file")
- **Modified** → `git add foo.txt` → **Staged**
- **Modified** → `git restore foo.txt` → **Unmodified**
- **Unmodified** → `edit foo.txt` → **Modified** (with your favorite editor)
- **Staged** → `git commit` → **Unmodified**
- **Staged** → `git restore --staged` → **Modified**

Again, `git status` will often give you advice of how to undo a state change.

11.2 Unmodified to Untracked

A variation of `git rm` tells Git to remove the file from the repo but leave it intact in the working tree. Maybe you want to keep the file around but don't want Git to track it any longer.

To make this happen, you use the `--cached` switch.

Here's an example where we remove the file `foo.txt` from the repo but keep it around in our working tree:

```
$ ls
foo.txt

$ git rm --cached foo.txt
rm 'foo.txt'

$ git status
On branch main
Changes to be committed:
  (use "git restore --staged <file>..." to unstage)
    deleted:    foo.txt

Untracked files:
  (use "git add <file>..." to include in what will be committed)
  foo.txt
```

```
$ ls
foo.txt
```

There you see in the `status` output that Git has staged the file for deletion, but it's also mentioning that the file exists and is untracked. And a subsequent `ls` shows that the file still exists.

At this point, you can commit and the file would then be in Untracked state.

11.3 Files In Multiple States

A file can actually sort of exist in multiple states at once. To be more technically accurate, there can be copies of files which are in different states than one another. For instance, you might have one version of a file on the stage, and another version of that file, with different modifications, in your working tree *at the same time*. Technically these are actually different files since they don't contain the same data.

Just remember that when you stage a file, it effectively stages a **copy** of that file as it exists right then. There is nothing stopping you from making another modification to the file in the working tree and ending up like this, where one version of the file is on the stage ready to commit, and another one is in the working tree with additional changes not-yet-staged:

```
$ git status
On branch main
Changes to be committed:
  (use "git restore --staged <file>..." to unstage)
    modified:   foo.txt

Changes not staged for commit:
  (use "git add <file>..." to update what will be committed)
  (use "git restore <file>..." to discard changes in working
  directory)
    modified:   foo.txt
```

You can overwrite the version on the stage by adding it again. And various incantations of `restore` can change the files in different ways. Look up the `--staged` and `--worktree` options for `git restore`.

I'll leave how to move files around in these simultaneous states as an exercise to the reader, but I wanted you to at least be aware of it.

Chapter 12

Comparing Files with Diff

The powerful `git diff` command can give you differences between two files or commits. We mentioned it briefly at the beginning, but here we're going to delve more deeply into all the things you can do with it.

It's not the easiest thing to read at first, but you do get used to it after a while. My most common use case is to quickly scan to remember what I've changed in the working tree so I know what to add to the stage and what commit message to use.

12.1 Basic Usage

The most basic use case is that you've modified some files in your working tree and you want to see what the differences are between what was there and what you added.

For example, let's say I've modified my `hello.py` file (but haven't staged it yet). I can check out what I've changed like so:

```
$ git diff
diff --git a/hello.py b/hello.py
index 4a8f53f..8ee1fe4 100644
--- a/hello.py
+++ b/hello.py
@@ -1,4 +1,8 @@
 def hello():
-    print("Hello, world!")
+    print("HELLO, WORLD!")
+
+def goodbye():
+    print("See ya!")

hello()
+goodbye()
```

What do we have there? Why, it's an impenetrable mess, of course!

The End

All right, take a deep breath and let's figure it out.

Since the output is plastered over with `hello.py`, we can safely assume this is the file we're talking about. If the diff is reporting on multiple files (e.g. you're comparing two commits), each file will have its own

section in the output.

The index line has the blob hashes and file permissions. A blob hash is the hash of the specific file in the states being compared. This isn't something you need to worry about, typically. Or maybe not even ever.

After that we have a couple lines indicating that the old version of the file `a/hello.py` is the one marked with minus signs, and the new version (that you haven't staged yet) is `b/hello.py` and is marked with plus signs.

Then we have `@@ -1,4 +1,8 @@`. This means that lines 1-4 in the old version are shown, and lines 1-8 in the new version are shown. (So clearly we've at least added some lines here.)

Finally, we get to the steak and potatoes of the whole thing—what has actually changed? Remembering that the old version is minus and the new version is plus, let's look at just that part of the diff again:

```
def hello():
-   print("Hello, world!")
+   print("HELLO, WORLD!")
+
+def goodbye():
+   print("See ya!")

hello()
+goodbye()
```

Rules:

- If a line is prefixed with `-`, it means this is how the line was in the old version.
- If a line is prefixed with `+`, it means this is how the line is in the new, modified version.
- If a line is not prefixed with anything, it means it is unchanged between the versions.

The diff won't show you all the lines of the file! It only shows you what's changed and some of the surrounding lines. If there are changes in different parts of the file, the unchanged parts of the file will be skipped over in the diff.

Another way to read the diff is that lines with a `-` have been removed and lines with a `+` have been added.

12.2 Diffing the Stage

What if you've added some stuff to the stage and you want to diff it against the previous commit?

Just typing `git diff` shows nothing!

Why? It's because diff, by default, is showing *the difference between your working tree and the stage*. You just staged that file, copying it from the working tree to the stage, so the two are identical. So a diff shows no differences.

How do we diff the stage with the previous commit?

The answer is really easy: `git diff --staged`¹. Done.

But I want to use this subsection to dig a little deeper into what's happening so you can improve your understanding of how this works.

Mental model time!

¹The `--staged` flag is more modern. Older versions of Git used `git diff --cached`.

Let's say that these two things are true. Now, whether or not they're true doesn't really matter.

“It's only a model.”
—Patsy, *Monty Python and the Holy Grail*

1. The stage contains a copy of **all** unmodified files at your current commit.
2. A `git status` or `git diff` only shows files that differ between your working tree and the stage.

So if you don't have any modifications, `git diff` won't show any differences. Because the stage and working tree are the same.

Now if you modify a file in your working tree and then `git diff`, you *will* see some changes, because the working tree differs from the stage.

But then if you add the modified file to the stage, then the stage and working tree become the same again. And `git diff` will show no differences.

`git diff` *always* compares the working tree to the stage. (Unless you're diffing specific commits—see below.) And in this case, after you've added your modified file to the stage, it's the same as the working tree. So no diffs.

Contrast this to where you've modified the working tree but *haven't* added the file to the stage. In this case, the file on the stage is just like the last commit, which is different than your working tree. So `git diff` shows the differences.

Well, okay, then... what if you *want* to diff what's on the stage with the last commit? That is, instead of diffing the working tree with the stage, you want to diff the stage with the `HEAD`?

Back to the punchline:

```
$ git diff --staged
```

And that'll do it. This will run a diff between what's on the stage and the last commit, showing you the changes you've staged.

12.3 More Diff Fun

Let's speed through some examples of things you can do with diff.

12.3.1 Diff Any Commits or Branches

You have more at your disposal than just diffing the working tree or stage. You can actually diff any two commits. This will show you all the differences between them.

For example, if you know the commit hashes, you can diff them directly:

```
$ git diff d977 27a3
```

Or if you have two branch names:

```
$ git diff main topic
```

Or mix and match:

```
$ git diff main 27a3
```

Or use `HEAD`:

```
$ git diff HEAD 27a3
```

Or relative `HEAD`... This one diffs the previous-to-`HEAD` commit with the `HEAD`:

```
$ git diff HEAD^ HEAD
```

And this one diffs four commits before `HEAD` with three commits before `HEAD`:

```
$ git diff HEAD~4 HEAD~3
```

12.3.2 Diffing Order

These are both valid ways to diff, but they give different (inverted) results:

```
$ git diff main topic
$ git diff topic main
```

One way to think about this is that it's like:

```
$ git diff FROM TO
```

That is, “Hey, Git, tell me the changes I need to make to get from commit `FROM` to commit `TO`.”

Let's say I made a file `foo.md` and committed it with a single line `First` in it. And then I overwrote it with `Second` and committed it again.

In this example, I can ask, “What do I have to change from the previous-to-`HEAD` commit to the `HEAD` commit?”

```
$ git diff HEAD^ HEAD
diff --git a/foo.md b/foo.md
index d00491f..495a7e9 100644
--- a/foo.md
+++ b/foo.md
@@ -1,1 @@
-First
+Second
```

It's telling me to get from previous-to-`HEAD` to `HEAD`, I would need to delete `First` and add `Second`.

But if I reverse it and ask, “What do I have to change from `HEAD` to get back to the previous-to-`HEAD` commit?” I'll get the opposite:

```
$ git diff HEAD HEAD^
diff --git a/foo.md b/foo.md
index 495a7e9..d00491f 100644
--- a/foo.md
+++ b/foo.md
@@ -1,1 @@
-Second
+First
```

There it's telling me to get back to the previous-to-`HEAD` I'd need to delete `Second` and add `First`.

So remember, `git diff FROM TO` is telling you the changes you have to make to get from the `FROM` commit to the `TO` commit.

12.3.3 Diffing with Parent Commit

We just showed this example:

```
$ git diff HEAD~4 HEAD~3
```

But since `HEAD~4` is the parent of `HEAD~3`, is there some shorthand we can use here? Yes!

```
$ git diff HEAD~4 HEAD~3
$ git diff HEAD~3^!           # Same thing!
```

You can use it anywhere you want to compare a commit with its parent, which is really showing just what changes were in that one particular commit.

```
$ git diff HEAD^!
$ git diff HEAD~3^!
$ git diff main^!
$ git diff 27a3^!
```

12.3.4 More Context

By default, `git diff` shows 3 lines of context around the changes. If you want to see more, like 5 lines, use the `-U` switch.

```
$ git diff -U5
```

12.3.5 Just the File Names

If you just want a list of files that have changed, you can use the `--name-only` option.

```
$ git diff --name-only
```

12.3.6 Ignoring Whitespace

There might be a time when you get some tabs/spaces confusion in your source code, which is always painful. Protip: stick to one and force everyone else on the team to do the same under penalty of paying for lunch.

But you can commit `git diff` to ignore whitespace in the comparison:

```
$ git diff -w
$ git diff --ignore-all-space # Same thing
```

12.3.7 Just Certain Files

You can just diff certain files.

One way is to just put the file names after a `--`:

```
$ git diff -- hello.py
$ git diff -- hello.py another_file.py
```

You can also specify commits or branches before the `--`:

```
$ git diff somebranch -- hello.py
```

That'll compare `hello.py` at `HEAD` with the version on `somebranch`.

Or you could give two commits or branches to compare the file there:

```
$ git diff main somebranch -- hello.py
```

Finally, you can restrict to a file extension using a glob and single quotes:

```
$ git diff '*.py'
```

That will just diff the Python files.

12.3.8 Inter-branch Diffs

This is an interesting version of comparing two branches.

We already showed the following example for comparing the commits at two branches:

```
$ git diff branch1 branch2
```

But sometimes you want to know what changed in a branch *since the branches diverged*.

That is, you don't want to know what's different *now* between `branch1` and `branch2`, which is what the above would give you.

You want to know what `branch2` added or deleted that `branch1` did not.

In order to see this, you can use this notation:

```
$ git diff branch1...branch2
```

This means “diff the common ancestor of `branch1` and `branch2` with `branch2`.”

In other words, tell me all the changes that were made in `branch2` that `branch1` is unaware of. Don't show me anything that `branch1` has changed since they diverged.

12.4 Difftool

I know the diff output is tough to read. I recommend practice and offer myself as living proof that with enough practice, the output becomes penetrable. And eventually it even becomes easy to read, which might be difficult to imagine. But it does!

That said, there are third-party tools that exist to make diffs more manageable, and Git supports these tools. You can read more about it in the diff tool chapter.

Chapter 13

Renaming and Removing Files

This is an extension of dealing with file states, so make sure you read that chapter first!

Also, I'm going to interchangeably use the terms *rename* and *move* to mean the same thing. Moving as a concept is a little more powerful because not only can it rename, but it can also move files to other directories. It's notable because the command to rename is `git mv`.

13.1 Renaming Files

You can use the OS rename command to rename files, but if they're in a Git repo, it's better to `git mv` them so that Git has total awareness.

Git is confusingly unhelpful with this.

Let's rename `foo.txt` to `bar.txt` and get a status:

```
$ git mv foo.txt bar.txt
On branch main
Changes to be committed:
  (use "git restore --staged <file>..." to unstage)
    renamed:   foo.txt -> bar.txt
```

So it knows the file is renamed, and the file has been moved to the stage. Like so:

- **Unmodified** → `git mv foo.txt bar.txt` → **Staged** (as “renamed”)

And if we look, we see the file has actually been renamed in the directory to `bar.txt`, as well.

If we make a commit at this point, the file will be renamed in the repo. Done.

But what if we want to undo the rename?

Git suggests `git restore --staged` to the rescue... But which file name to use, the old one or new one? And then what? It turns out that while you *can* use `git restore` to undo this by following it with multiple other commands, you should, in this case, ignore Git's advice, and instead read the following section.

13.2 Unrenaming Files from the Stage

Just remember this part: **the easiest way to undo a Staged rename is to just do the reverse rename.**

Let's say we renamed and got here:

```
$ git mv foo.txt bar.txt    # Rename foo.txt to bar.txt
$ git status
On branch main
Changes to be committed:
  (use "git restore --staged <file>..." to unstage)
    renamed:   foo.txt -> bar.txt
```

This easiest way to revert this change is to do this:

```
$ git mv bar.txt foo.txt    # Rename it back to foo.txt
$ git status
On branch main
nothing to commit, working tree clean
```

And there you go.

In summary, the way to rename a file is:

- **Unmodified** → `git mv foo.txt bar.txt` → **Staged**
- **Staged** → `git commit` → **Unmodified**

And the way to back out of a Staged rename is to rename them back the way they were:

- **Staged** → `git mv bar.txt foo.txt` → **Unmodified**

13.3 Removing Files

You can use the OS remove command to remove files, but if they're in a git repo, it's better to `git rm` them so that Git has total awareness.

And what happens might seem a little strange.

Let's say we have a file `foo.txt` that has already been committed. But we decide to remove it.

```
$ git rm foo.txt
rm 'foo.txt'          # This is Git's output
```

This actually removes the file—if you look in the directory, it's gone.

But let's check the status:

```
$ git status
On branch main
Changes to be committed:
  (use "git restore --staged <file>..." to unstage)
    deleted:   foo.txt
```

So the now-deleted file is in Staged State, as it were. Which makes sense since there's now a “difference” between the working tree (where the file is gone) and the stage (where the file still exists).

If we do a commit here, the file is deleted. Done.

13.4 Unremoving Files from the Stage

But what if we want to undo the staging of the now-deleted file? There's a hint for how to get it back with `git restore --staged`, as per usual.

Let's try it:

```
$ git restore --staged foo.txt
$ git status
On branch main
Changes not staged for commit:
  (use "git add/rm <file>..." to update what will be committed)
  (use "git restore <file>..." to discard changes in working
  directory)
    deleted:    foo.txt

no changes added to commit (use "git add" and/or "git commit -a")
```

Hmmm. “Changes not staged for commit” are files in Modified State. This means that `foo.txt` has been “modified”, which is, in this context, a friendlier way of saying “deleted”.

So we've backed up from Staged State to Modified State. But looking around, the file is still gone! I want my file back!

We want to move it back to Unmodified State, which Git once again hints how to do in the status: `git restore`. Let's try:

```
$ git restore foo.txt
$ git status
On branch main
nothing to commit, working tree clean
```

Git's telling us there are no Modified files here. Let's look and see:

```
$ ls foo.txt
foo.txt
```

There it is, back safe and sound.

So the process for deleting a committed file is a variant of what we've already seen:

- **Unmodified** → `git rm foo.txt` → **Staged**
- **Staged** → `git commit` → The file is now gone

And you can undo a deleted file (as long as the delete hasn't yet been committed) in the same way you can undo any other file states:

- **Staged** → `git restore --staged foo.txt` → **Modified**
- **Modified** → `git restore foo.txt` → **Unmodified**

13.5 Unremoving Files from Earlier Commits

What if there's a file that was removed some time ago and you want it back?

1. Find the commit hash where the file exists.
2. Restore the file from that commit.

Presumably you know the name of the file, but if you don't, you'll have to painstakingly pore over the logs with `git log --name-only` until you find it.

But let's say you know the name. In this case, you can get the log for the deleted file like so (assuming the file we want is `foo.txt`):

```
$ git log -- foo.txt
commit 97bdb61727f7515d6953c965f56ef8329585f348
Author: User <user@example.com>
Date: Sun Jan 12 11:08:33 2025 -0800

    Removed due to horrid commit messages

commit 1c9bf4514ee90a0e65fb9b0a916765bb6c78dee6
Author: User <user@example.com>
Date: Sun Jan 12 11:08:33 2025 -0800

    Add the barfsplant

commit cc7a1940f13fca9092dbe9ce4a8e9012babd9314
Author: User <user@example.com>
Date: Sun Jan 12 11:08:33 2025 -0800

    Initial splungification
```

There we see the history of the illustrious `foo.txt`.

We see it was removed in commit `97bdb`. So no point in restoring it from there (it's already gone by then!). But the commit just *prior* to that (`1c9bf`) is the most recent version of `foo.txt` before it was deleted. That's probably what we want. (Or maybe an earlier one if you want to go back farther in time—no law against that.)

And the restore is pretty easy:

```
$ git restore --source=1c9bf foo.txt
$ ls foo.txt
foo.txt
```

There it is! But in what state?

```
$ git status
On branch main
Untracked files:
  (use "git add <file>..." to include in what will be committed)
  foo.txt
```

It's not even added yet. So if you want to bring it back to life, you'll have to add and commit it just as if it were a brand new file.

13.6 A Note on Removing Secrets

We've seen that once something is committed and deleted, it's possible to resurrect that thing.

Now, let's say you've committed some code that looks like this:

```
MASTER_PASSWORD_FOR_THE_ENTIRE_COMPANY=pencil
```

And then you make the horrible mistake of pushing it.

That's bad enough, but let's say it's even worse and you pushed it to a repo on GitHub that has public access.

Now the entire world has your password! You're hosed!

"But wait! I'll just remove it real fast and push and no one will notice!"

No. The company can't take that chance. Anyone can clone the repo and look back in the history to get the deleted file. The only recourse is to change that password immediately. Throughout the entire company. That is what **must** happen. Your manager is not amused.

Never, EVER commit secrets to Git. Use a dot-env^a file or literally anything other than committing the secret.

^aA dot-env (.env) file is one that contains secret information (like login credentials) that is never committed to the repo. It's usually in the .gitignore just to be sure. Someone related to the project will use a side channel to tell you what to put in it so you can authenticate properly. Support for .env files exists for a variety of languages and frameworks. I'm using my serious voice because this is a serious matter!

Let's make the infraction less severe. Let's say you've pushed to GitHub, but it's a private repo. It's still kinda bad. You have to trust everyone who has access, and trust that no clones of the repo will ever end up in the hands of anyone outside the company or those of any disgruntled employees. The only recourse is to change that password.

Okay. Let's make it even *less* severe, still. Let's say you've committed the password to your repo, *but you haven't yet pushed.*

Now we can do something about it because there's no chance anyone other than you has seen the code. You didn't push it, so no one can have pulled it. But we'll not talk about that here; see the chapter on Amending Commits for fixing the file before the push.

Chapter 14

Collaboration across Branches

Let's say you're on a team of coders and you all have access to the same GitHub repo. (One person on the team owns the repo, and they've added you all as collaborators¹.)

I'm going to use the term *collaborator* to mean “someone to whom you have granted write access to your repo”.

How can you all structure your work so that you're minimizing conflicts?

There are a number of ways to do this.

- Everyone is a collaborator on the repo, and:
 - Everyone uses the same branch, probably `main`, or
 - Everyone uses their own remote tracking branch and periodically merges with the main branch, or
 - Everyone uses their own remote tracking branch and periodically merges with a development branch, which itself is periodically merged into `main` for each official release.
- Or everyone has their own repo (and are not collaborators on the same repo), and:
 - Everyone uses *pull requests* or other synchronization methods to get their repos merged into the other devs'.

We'll look at the first few ways in this chapter, but we'll save pull requests for later.

There's no one-size-fits-all approach to teamwork with Git, and the methods outlined below can be mixed and matched with local topic branches, or people having multiple remote tracking branches, or whatever. Often management will have an approach they want to use for collaboration which might be one of the ones in this section, or maybe it's a variant, or maybe it's something completely different.

In any case, the best strategy for you, the learner, is to just be familiar with the tools (branching, merging, conflict resolution, pushing, pulling, remote tracking branches) and use them for effect where it makes the most sense.

And when you're first starting out, your intuition about “where it makes the most sense” might not be dead-on, but it probably won't be lethal and you'll figure it out in the school of hard knocks.

“Oh great. Another f---ing learning experience.”
—Actual quote from my mother

Finally, I'll be using GitHub in all these examples, but you could use any server or service as the remote instead.

¹<https://tinyurl.com/y5kzpeyk>

14.1 Communication and Delegation

Git can't save you from poor communication. The only way to minimize conflicts in a shared project is to communicate with your team and clearly assign different tasks to people in a non-conflicting way.

Two people shouldn't generally be editing the same part of the same file, or even any part of the same file. That's more of a guideline than a rule, but if you follow it, you will never have a merge conflict.

As we've seen, it's not the end of the world if there is a merge conflict, but life sure is easier if they're just avoided.

Takeaway: Without good communication and a good distribution of work on your team, you're doomed. Make a plan where no one is stepping on toes, and stick to it.

14.2 Approach: Everyone Uses One Branch

This is really easy. Everyone has push access to the repo and does all their work on the `main` branch.

Benefits:

- Super simple to set up.
- Conceptually not much to juggle.
- All work instantly available to all collaborators upon push.

Drawbacks:

- More potential for merge conflicts.
- Unless you're rebasing (more on that later), you'll have a lot of merge commits.
- You can't push non-working code since it will break everything for everyone else.

Initial setup:

- One person makes the GitHub repo.
- The owner of the GitHub repo adds all the team members as collaborators.
- Everyone clones the repo.

Workflow:

- Work is delegated to all collaborators. The work should be as non-overlapping as possible.
- Everyone periodically pulls `main` and resolves any merge conflicts.
- Everyone pushes their work to `main`.

In real life, this approach is probably only used on very small teams, e.g. three people at most, with frequent and easy communication between all members. If you're working on a small team in school, it could very well be enough, but I'd still recommend trying a different approach just for the experience.

The other approaches are not that much more complex, and give you a lot more flexibility.

14.3 Approach: Everyone Uses Their Own Branch

In this scenario, we treat `main` as the working code, and we treat contributors' branches as where work is done. When a contributor gets their code working, they merge it back into `main`.

Benefits:

- You get to work on your own branch without worrying about messing up other people's work.
- You can commit non-working code since no one else can see it. (You might be wrapping up the work day and want to push some incomplete code for a backup, for example.)
- Less merge conflict potential since fewer merges are happening than if everyone were committing to `main`.

Drawbacks:

- If your branch diverges too far from `main`, merging might become painful.
- Unless you're rebasing and squashing, the incremental work on your branch might "pollute" the commit history on `main` with a lot of tiny commits.

Initial setup:

- One person makes the GitHub repo.
- The owner of the GitHub repo adds all the team members as collaborators.
- Everyone clones the repo.
- Everyone makes their own branch, possibly naming it after themselves.
- Everyone pushes their branch to GitHub, making them remote-tracking branches. (We do this so that your work is effectively backed up on GitHub when you push it.)

Workflow:

- Work is delegated to all collaborators. The work should be as non-overlapping as possible.
- As collaborators finish their tasks, they will:
 - Test everything on their branch.
 - Merge the latest `main` into their branch; do a pull to make sure you have it. (The collaborator might already have the latest `main` if no one else has merged into it, which will cause Git to say there's nothing to do. This is fine.)
 - Test everything, and fix it if necessary.
 - Merge their functioning branch into `main`.
 - Push.
 - If someone else has modified `main` while you were testing, Git will complain that you have to pull before you can push. If there's a conflict at this point, you'll have to resolve, test, and push it. And you'll have to merge `main` back into your branch so that your branch is up-to-date.

The result will look something like Figure 14.1 to start, where all the collaborators have made their own branches off of `main`.

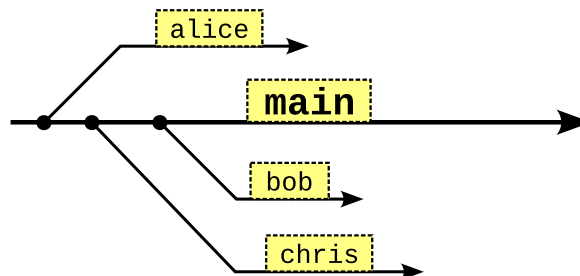

Figure 14.1: Collaborators branching off `main`.

Let's say Chris (on branch `chris`) finishes up their work and wants other contributors to be able to see it. It's time to merge into `main`, as we graphically see in Figure 14.2.

After that, other contributors who pull `main` will see the changes.

14.4 Approach: Everyone Merges to the Dev Branch

In this scenario, we treat `main` as the published code that we're going to distribute, often tagged with a release version number, and we treat a `dev` branch as the working, unreleased code. And, as in the previous scenario, everyone has their own branches they're developing on.

The idea is basically we're going to have two versions of the working code:

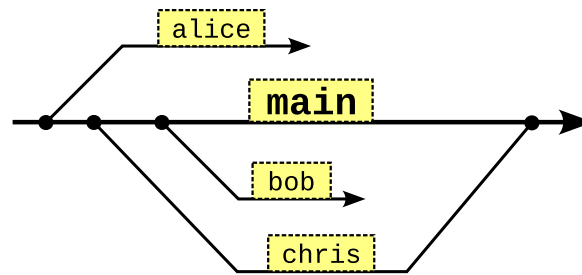
Figure 14.2: Chris merges back into `main`.

1. The public, released version that's on `main`.
2. The private, internal version that's on `dev`.

And then, of course, we'll have one branch per collaborator.

Another way of thinking about it is that we're going to have our internal build on `dev` that is good for testing and then, when it's all ready, we'll "bless" it and merge it into `main`.

So there will be a lot of merges into `dev` from all the developer branches, and then every so often there will be a merge from `dev` into `main`.

The developers will never directly merge into `main`! Usually that is performed by someone in a managerial role.

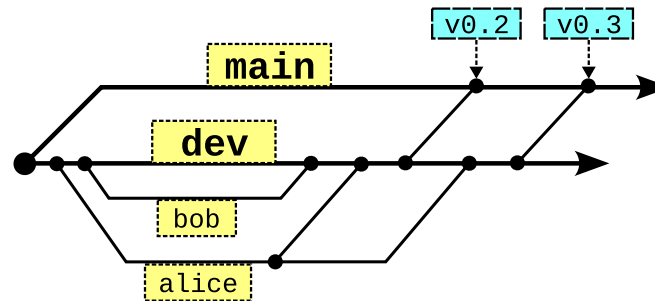
Figure 14.3: Working on the `dev` branch.

Overall the process works as in Figure 14.3. This is a busy image, but notice how Bob and Alice are only merging their work into the `dev` branch, and then every so often, their manager merges the `dev` branch into `main` and tags that commit with a release number.

Benefits:

- All the benefits of everyone having their own branch.
- You have an internal branch from which you can make complete builds for internal or external testing.

Drawbacks:

- A little more complexity and management.
- If your branch diverges too far from `dev`, merging might become painful.
- If the `dev` branch diverges too far from `main`, merging might become painful.
- Unless you're rebasing, the incremental work on your branch might "pollute" the commit history on `dev` and `main` with a lot of tiny commits.

Initial setup:

- One person makes the GitHub repo.

- The owner of the GitHub repo adds all the team members as collaborators.
- The owner creates the `dev` branch.
- Everyone clones the repo.
- Everyone makes their own branch, possibly naming it after themselves.
- Everyone pushes their branch to GitHub, making them remote-tracking branches. (We do this so that your work is effectively backed up on GitHub when you push it.)

Workflow:

- Work is delegated to all collaborators. The work should be as non-overlapping as possible.
- As collaborators finish their tasks, they will:
 - Test everything on their branch.
 - Merge the latest `dev` into their branch; do a pull to make sure you have it. (The collaborator might already have the latest `dev` if no one else has merged into it, which will cause Git to say there's nothing to do. This is fine.)
 - Test everything, and fix it if necessary.
 - Merge their functioning branch into `dev`.
 - Push.
 - If someone else has modified `dev` while you were testing, Git will complain that you have to pull before you can push. If there's a conflict at this point, you'll have to resolve, test, and push it. And you'll have to merge `dev` back into your branch so that your branch is up-to-date.

Managerial Workflow:

- Coordinate with all devs to get a candidate release in `dev` tested out and ready.
- Merge that candidate release (some commit) from `dev` into `main`.
- Tag the `main` commit with some version number, optionally.

Chapter 15

Rebasing: Moving Commits

I'm going to start with the Number One Rule of Rebasing: *never rebase anything that you have pushed*. That is, only rebase local changes that no one else has seen. You can push them after the rebase.

This is more of a guideline than a rule in that you can rebase things you've pushed *if you understand the consequences*. It's typically not a great situation, though, so you'll want to generally avoid it.

The reason is that rebasing *rewrites history*. And that makes your history get out of sync with the history of other devs who have cloned the repo with the old history, and it makes syncing up quite challenging.

There are other commands in Git that also rewrite history. And the general rule is *never rewrite history on anything that's already been pushed*. Unless you really know what you're doing.

15.1 Contrasted to Merging

But before we go run off in high spirits talking about rebasing, let's do a quick merge refresher. Here's a variation of an earlier example where we have two divergent branches, Figure 15.1. Let's say you're working on the `topic` branch.

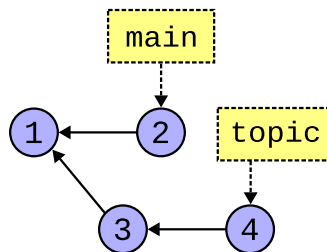

Figure 15.1: Two divergent branches.

Then you hear that someone has made a change to `main` and you want to roll those changes into your `topic` branch, but not necessarily get your changes in `main` yet.

At this point, if we wanted to get the changes in `main` into `topic`, our merge option was to make another commit, the *merge commit*. The merge commit contains the changes from two parent commits (in this case the commit labeled (2) and the one labeled (4) are the parents) and makes them into a new commit, marked (5) in Figure 15.2.

If we look at our log at that point, we can see the changes from all the other commits in the graph from the `topic` branch.

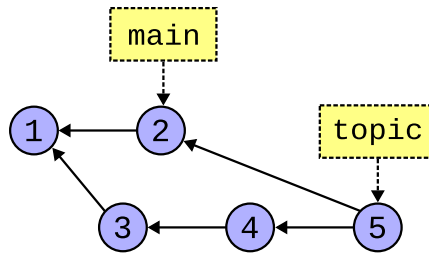

Figure 15.2: Two divergent branches, merged.

And we're good at this point. That worked, and it did what we wanted. Merging is a completely acceptable solution to this problem.

But there are a couple drawbacks to doing the merge. See, we really just wanted to get the latest stuff from `main` into our branch so we could use it, but we didn't really want to commit anything. But here we've made a new commit for everyone to see.

Not only that, but now the commit graph forms a loop, so the history is a little more convoluted than perhaps we'd like it.

What really would have been nice is if I could just have taken commits (3) and (4) from `topic` and just somehow applied those changes to (2) on `main`. That is, could we pretend that instead of branching off (1) like `topic` did, that we instead branched off (2)?

After all, if we branched off (2), then we'd have those changes from `main` that we wanted.

What we need is a way to somehow rewind our commits back to the branch point at (1), and then reapply them on commit (2). That is, the base of our `topic` branch, which was commit (1), needs to be changed to another base at commit (2). We want to **rebase** it to commit (2)!

15.2 How it Works

So let's do exactly that. Let's take the changes we made in commit (3) and apply them to `main` at commit (2). This will make a brand new commit that includes changes from both commit (2) and commit (3). (Importantly, this commit didn't exist before; there was no commit that contained changes from (2) and (3).) We'll call this new commit (3') ("three prime"), since it has the changes that we made in (3).

After that, we'll do the same thing with commit (4). We'll apply the changes from old commit (4) to (3'), making a new commit (4').

And if we do that, we end up with Figure 15.3.

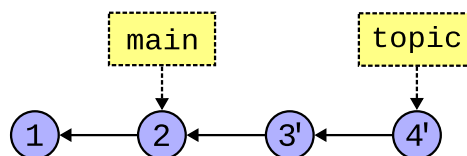
Figure 15.3: `topic` branch rebased on `main`.

And there you see (3') and (4') now rebased onto `main`! And now the `topic` branch includes commit (2) from the `main` branch!

Again, these two commits have the same changes that you originally had in commits (3) and (4), but now they've been applied to `main` at commit (2). So the code is necessarily different since it now contains the

changes from `main`. This means your old commits (3) and (4) are effectively gone, and the rebase has replaced them with two new commits that contain the same changes, just on a different base point.

We just changed history. When we mentioned rewriting history at the top of this chapter, this is what we were talking about. Imagine some other dev had your old commits (3) and (4) and was working off those making their own new commits. And then you rebased effectively destroying commits (3) and (4). Now your commit history is different than the other dev's and all kinds of *Fun*TM will be had trying to sort it out.

If you only rebase commits that you haven't pushed, you'll never get into trouble. But if some other dev has a copy of your commits (because you've already pushed them and they pulled them), don't rebase those commits!

15.3 When Should I Do This?

There's no fixed rule about this. Sometimes a shop will have one, saying that everyone should rebase all the time so that the commit history has a cleaner look (no merge commits, no loops).

Other shops will say to merge all the time so that the complete history is preserved.

15.4 Pulling and Rebasing

If you might recall from way back when, doing a pull is actually a couple operations: *fetch* and *merge*.

The fetch downloads all the new data from the remote, but doesn't actually merge anything into your branches or working tree. So you won't see any local changes after a fetch.

But the pull follows it up with a standard merge so that you see the remote tracking branch's changes in your local branch.

So, assuming you have everything set up and you're on your `main` branch, when you do this:

```
$ git pull
```

Git actually does something like this:

```
git fetch          # Get all the information from origin
git merge origin/main # Merge origin/main into main
```

(Recall that `origin/main` is your remote-tracking branch—it's the version of `main` that's on `origin`, not the `main` on your local machine.)

But merging isn't the only thing you can do there. Given that this is the chapter on rebasing, you might correctly suspect that we can make it do a rebase instead.

And here's how:

```
$ git pull --rebase
```

That causes these two things to happen:

```
git fetch          # Get all the information from origin
git rebase origin/main # Rebase main into origin/main
```

If you want that to be the default behavior for the current repo, you can run this one-time command:

```
$ git config pull.rebase true
```

If you want it to be the default behavior for all repos, you can:

```
$ git config --global pull.rebase true
```

If you've configured your repo to always rebase on a pull, you can override that to force a merge (if you want) with:

```
$ git pull --no-rebase # Do a merge instead of a rebase
```

15.5 Conflicts

When you do a merge, there's a chance that you might conflict with some of the changes in the other branch, and you have to resolve those, as we've seen.

Can the same thing happen with a rebase?

Of course! If the commit you're trying to rebase onto conflicts with your commit, you'll have the same trouble you'd have with a merge.

Luckily, Git will let you resolve the conflict in a way similar to the merge.

Let's start with a simple example. I'm going to have a text file that contains the following:

```
The magic number is 1.
```

We'll have that in a commit on the `main` branch.

Then we'll make a new `topic` branch there.

Then on the `main` branch we'll change the number to `2` and commit.

And on the `topic` branch we'll change the number to `3` and commit.

So we'll have the scenario in Figure 15.4.

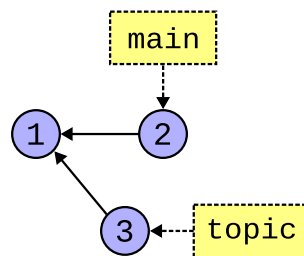

Figure 15.4: Branches ready for conflict.

Finally, we'll try to rebase `topic` onto `main`.

At that point, Git will become confused. It knows the last commit on `main` has `2` and that `topic` is unaware of this (because it branched off before that change). And it knows the last commit on `topic` has `3`. So which one is right?

Let's try to rebase while we're on the `topic` branch and see what happens.

```

$ git rebase main
Auto-merging magic.txt
CONFLICT (content): Merge conflict in magic.txt
error: could not apply 9f19221... Update to 3
hint: Resolve all conflicts manually, mark them as resolved with
hint: "git add/rm <conflicted_files>", then run "git rebase
hint: --continue".
hint: You can instead skip this commit: run "git rebase --skip".
hint: To abort and get back to the state before "git rebase", run
hint: "git rebase --abort".
hint: Disable this message with "git config advice.mergeConflict
hint: false"
Could not apply 9f19221... Update to 3

```

Whoa, Nelly. OK, so it can't do that. It says we need to “Resolve all conflicts manually”, and then add them, and then we'll run rebase again with the `--continue` flag to continue the rebase.

If you keep reading the hints, you'll see there some more stuff in there. We'll get to `--skip` later, but do note that if the conflict is more than you want to take on right now, you can just run:

```
$ git rebase --abort
```

to pretend you never started it in the first place.

This might sound a little familiar. It's basically the same process as we went through with the merge conflict.

1. Edit the conflicting file and make it *Right*.
2. Add it.
3. Continue the rebase.

Let's do that. If I pop open that file `magic.txt` in my editor, I see:

```

1 <<<<<< HEAD
2 The magic number is 2
3 =====
4 The magic number is 3
5 >>>>>> 9f19221 (Update to 3)

```

That's just like in a merge conflict—Git is showing us the two choices we have for this line. So we'll consult with the team and come to an agreement on what should be in the file, and we delete everything that shouldn't be there and we make it *Right*.

```
The magic number is 3
```

And I save that.

Now, what were we supposed to do at this point, again? If you've forgotten, it's fine. Just run `git status` to see where we're at.

```

$ git status
interactive rebase in progress; onto 6ceeefb
Last command done (1 command done):
  pick 9f19221 Update to 3
No commands remaining.

```

```

You are currently rebasing branch 'topic' on '6ceeebf'.
(fix conflicts and then run "git rebase --continue")
(use "git rebase --skip" to skip this patch)
(use "git rebase --abort" to check out the original branch)

Unmerged paths:
(use "git restore --staged <file>..." to unstage)
(use "git add <file>..." to mark resolution)
  both modified:   magic.txt

no changes added to commit (use "git add" and/or "git commit -a")

```

Oh yeah! `--continue`, right?

```

$ git rebase --continue
magic.txt: needs merge
You must edit all merge conflicts and then
mark them as resolved using git add

```

What? Oh, we should have read more of the status message. It says to use `git add` to mark resolution of the file `magic.txt`. Let's do that.

```

$ git add magic.txt
$ git status
interactive rebase in progress; onto 6ceeebf
Last command done (1 command done):
  pick 9f19221 Update to 3
No commands remaining.
You are currently rebasing branch 'topic' on '6ceeebf'.
(all conflicts fixed: run "git rebase --continue")

Changes to be committed:
  (use "git restore --staged <file>..." to unstage)
    modified:   magic.txt

```

That status looks nicer. (But note that Git's in a special "rebase" state similar to how it gets into a special "merge" state when merging. We have to either abort or continue before we can use Git normally again.)

Now `--continue`.

```

$ git rebase --continue

```

This pops me into my editor to edit the commit message. This is your opportunity to change the commit message if it no longer reflects the commit. (That is, if you changed the commit when resolving the conflict to be something entirely different, you might need to edit the message.) Edit it if necessary and save it.

And Git says:

```

[detached HEAD 443fa53] Update to 3
 1 file changed, 1 insertion(+), 1 deletion(-)
Successfully rebased and updated refs/heads/topic.

```

And `git status` shows we're all clear.

After all that, we see our new commit graph in Figure 15.5.

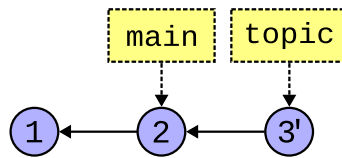

Figure 15.5: After rebase conflict resolution.

One last note: if you find yourself resolving the same conflicts with a rebase over and over with every pull, you might check out `git rerere`¹ to help automate that process.

15.6 Squashing Commits

This concept fits in with the notion of a clean commit history.

Let’s say you were tasked with implementing a feature, namely adding an alert box saying that the storage limit was exceeded.

No problem. You add it and commit with message “Added feature #121”. (And you don’t push yet.)

```
alert("Strrage limit exceeeded");
```

Then after the commit, you notice a typo. Heck.

So you fix it and commit with message “Fixed typo”.

```
alert("Storage limit exceeeded");
```

Done.

Wait! There’s another typo! Are you kidding me?

So you fix it:

```
alert("Storage limit exceeded");
```

And add another commit saying “Fixed another typo”.

Now your local commit history reads:

```
Fixed another typo
Fixed a typo
Added feature #121
```

That’s not super clean, right? Really this was supposed to be one commit that implemented feature #121.

But luckily you haven’t pushed yet, which means you’re still free to rewrite that history!

You can use a feature of rebase called **squashing** to get this done.

What you want to do is squash those two typo fixes into the previous commit, the one where you first tried to implement the feature.

First, let’s look at the log.

¹<https://git-scm.com/book/en/v2/Git-Tools-Rerere>

```

$ git log
commit c1820e6d0da19013208b389d264310162477b099 (HEAD -> main)
Author: User <user@example.com>
Date:   Wed Jul 17 11:53:10 2024 -0700

    Fixed another typo

commit c62c0db7b82e6b415d36bd0f00d568fd503164b7
Author: User <user@example.com>
Date:   Wed Jul 17 11:53:10 2024 -0700

    Fixed typo

commit ab84a428b8baae0078ee0647a67b34a89a6abed8
Author: User <user@example.com>
Date:   Wed Jul 17 11:53:10 2024 -0700

    Added feature #121

commit a95854659e31d203e2325eee61d892c9cdad767c
Author: User <user@example.com>
Date:   Wed Jul 17 11:53:10 2024 -0700

    Added

```

Since this is a rebase, we’re going to rebase onto something, namely the commit *prior* to the added feature commit, the commit ID starting with a9585.

And we want to do it *interactively*, which is a special rebase mode that lets us do the squashing, and we get there with the `-i` flag.

```
$ git rebase -i a9585
```

This brings us into an editor that has this information, and a huge comment block below it full of instructions.

```

1 pick ab84a42 Added feature #121
2 pick c62c0db Fixed typo
3 pick c1820e6 Fixed another typo

```

Notice that they’re listed in forward order instead of the reverse log order we’re used to.

Look at all those options shown in the comment block (and not shown here in the guide)! Pick, reword, edit, squash, fixup... so many things to choose from. As you might imagine we’re in a pretty powerful history rewriting mode.

For now, though, let’s just look at “squash” and “fixup”, which are almost the same thing.

Starting with “squash”, what I want to do is take those typo fix commits and work them into the “Added feature” commit. We can use the squash mode to do this.

I’ll edit the file to look like this:

```

1 pick ab84a42 Added feature #121
2 squash c62c0db Fixed typo
3 squash c1820e6 Fixed another typo

```

That will squash “Fixed another typo” into “Fixed typo” and then squash that result into “Added feature #121”.

And `pick` just means “use this commit as-is”.

| **There are shorthand versions for all these commands.** I could have used `s` instead of `squash`.

After I save the file, I get launched right back into another editor that has this in it:

```

1 # This is a combination of 3 commits.
2 # This is the 1st commit message:
3
4 Added feature #121
5
6 # This is the commit message #2:
7
8 Fixed typo
9
10 # This is the commit message #3:
11
12 Fixed another typo

```

We’re making a new rebased commit here with the three commits squashed into one, and so we get to write a new commit message. Helpfully, Git has included all three commit messages. Let’s hack it down to just have the commit message we want.

```

1 Added feature #121

```

And saving gets us back out with a message.

```

[detached HEAD 4bc6bca] Added feature #121
Date: Wed Jul 17 11:53:10 2024 -0700
1 file changed, 1 insertion(+)
 create mode 100644 foo.js
Successfully rebased and updated refs/heads/main.

```

Success is good. I like success.

| **What’s that about detached HEAD?** Git detaches the `HEAD` briefly when doing a rebase. Don’t worry—it gets reattached for you.

Now my commit history is all cleaned up.

```

commit 4bc6bca6870d124b3eebc9afd32486a5a23189fc (HEAD -> main)
Author: User <user@example.com>
Date: Wed Jul 17 11:53:10 2024 -0700

    Added feature #121

commit a95854659e31d203e2325eee61d892c9cdad767c
Author: User <user@example.com>
Date: Wed Jul 17 11:53:10 2024 -0700

    Added

```

And you can see, if you look at the earlier log, that the “Added feature” commit ID has changed. We did a rebase, after all, so those old commits are gone, replaced by the new ones.

Finally, after all this, *now* you can push. And always remember that since this is a history rewrite, you shouldn’t do it after you’ve pushed.

15.6.1 Squash versus Fixup

Now a quick note about `fixup` instead of `squash`. It’s the same thing, except only the squashed-into commit message is kept by default. So if I ran this:

```
1 pick fbc1075 Added feature #121
2 fixup fd4ca42 Fixed typo
3 fixup 6a10e97 Fixed another typo
```

Git instantly returns with:

```
Successfully rebased and updated refs/heads/main.
```

And Git log only shows the “Added feature #121” commit. With `fixup`, Git automatically discards the squashed commit messages.

15.7 Multiple Conflicts in the Rebase

When you merge with commit and there are multiple conflicts, you resolve them all in one big merge commit and then you’re done. You use `git commit` to wrap it all up.

Rebase is a little different. Since rebase “replays” your commits onto the new base one at a time, each replay is a merge conflict opportunity. This means that *as you rebase, you might have to resolve multiple conflicts one after another*.

For example, let’s say on your topic branch you made a commit that modified file `foo.txt`. And then you made *another commit* that modified file `bar.txt`.

But unbeknownst to you, someone on the `main` branch has also modified those two files, so they’re bound to conflict when you rebase.

And so you begin `git rebase main`, and we’re in trouble right off the bat. It’s telling us that `foo.txt` conflicts.

So you fix it up and then run `git rebase --continue` and edit the commit message, and get on with it.

But all that does is move on to your *next* commit to `bar.txt` and try to rebase that. And it conflicts, too!

So you fix it up and then run `git rebase --continue` and edit the commit message, and get on with it. Again.

And finally you get the success message:

```
[detached HEAD 31c3947] topic change bar
1 file changed, 1 insertion(+)
Successfully rebased and updated refs/heads/topic.
```

This is why you can conclude a merge with a simple commit, but you have to conclude a rebase by repeatedly running `git rebase --continue` until all commits have been rebased cleanly.

Is this good or bad? It might be better in that you get a chance to merge each commit in isolation so it might be easier to reason about and avoid errors. But at the same time it’s more legwork to get through it.

As always, use the right tool for the job!

Chapter 16

Stashing: Temporarily Set Changes Aside

If you're in the middle of working on something and you realize you want to pull some changes in, but you're not ready to make a commit because your stuff is still completely broken, `git stash` is your friend. It takes the stuff you're working on and stashes it away on the side, returning your working tree to the state of the last commit.

So your changes will look like they're gone—but don't worry, they're safely stashed away and you can bring them back later.

Then you can pull the new stuff down so you're up-to-date, and then unstash your stuff on top of it.

It's kind of like a mini rebase in spirit.

16.1 Example

Let's say we're all caught up to the latest.

```
$ git pull
```

Great. And we start hacking. We open an existing file `foo.rs` and add some code to it as per usual.

Then Chris calls from the next desk over and says, “Hey wait—I just made a critical update to `main` and you should use that!”

And you think, “Well, heck, I was in the middle of something.” You're not ready to commit, but you want Chris's changes.

So you save your files and then run this:

```
$ git stash
Saved working directory and index state WIP on main: c72c245
some very descriptive commit message
```

And, if you were watching, you might have seen your file in your editor change back to what it used to be! Your changes have been undone and stashed away!

If you `git status` at this point, you'll see:

```
$ git status
On branch main
Your branch is up to date with 'origin/main'.

nothing to commit, working tree clean
```

It's all clean, which means now you can pull and get the latest `main`. So you do that.

```
$ git pull
remote: Enumerating objects: 5, done.
remote: Counting objects: 100% (5/5), done.
remote: Total 3 (delta 0), reused 0 (delta 0), pack-reused 0
remote: (from 0)
Unpacking objects: 100% (3/3), 943 bytes | 943.00 KiB/s, done.
From /home/beej/tmp/origin
   10a8ad6..e286011  main       -> origin/main
Updating 10a8ad6..e286011
Fast-forward
 foo.rs | 1 +
 1 file changed, 1 insertion(+)
```

And now you're up to date.

Oh, wait. What was it we were working on? Oh yeah! We stashed it! Let's unstash those changes with `pop`:

```
$ git stash pop
Auto-merging foo.rs
On branch main
Your branch is up to date with 'origin/main'.

Changes not staged for commit:
  (use "git add <file>..." to update what will be committed)
  (use "git restore <file>..." to discard changes in working
  directory)
   modified:   foo.rs

no changes added to commit (use "git add" and/or "git commit -a")
Dropped refs/stash@{0} (046ac112f8c02c3dc02984ad71d353a3e5be9a7a)
```

Auto-merging sounds good. Looks like things went well. And if we look at our file now we'll see our changes brought out of the stash and reapplied. Our file `foo.rs` is in "modified" state and ready for us to work on, or add and commit.

16.2 The Stash Stack

If you're familiar with stack abstract data type¹, your ears might have perked up when you read `git stash pop`.

Yes, Git tracks stashes in a stack. If you're not familiar with a stack, read up on it first.

- `git stash` pushes the working tree on the stash stack.
- `git stash pop` pops the top of the stash stack and applies it to the working tree.

¹[https://en.wikipedia.org/wiki/Stack_\(abstract_data_type\)](https://en.wikipedia.org/wiki/Stack_(abstract_data_type))

- `git stash list` shows you the current stash stack.
- `git stash drop` deletes a particular stash stack entry.

Because of this, I could `stash`, then do something else, then `stash` again, and we'll have two stashes on the stack.

```
$ git stash list
stash@{0}: WIP on main: 659b132 added repo1 another line
stash@{1}: WIP on main: 659b132 added repo1 another line
```

The top of the stack is `stash@{0}`.

If I ran just plain `git stash pop`, it would take the stash at the top, which is index `0`, removing it from the stack and applying it to the working tree.

But you can also pop by stash name if you want to pop something from the middle of the stack.

```
$ git stash pop 'stash@{1}'
$ git stash pop --index 1      # same thing
```

Similarly `stash drop` will pop the top of the stack and **not** apply the changes to the working tree, discarding them instead.

And `stash drop` can also operate on a particular stash by name if you want to drop something from the middle of the stack.

16.3 Conflicts

Now that you've spent so much time reading about conflicts during merge and rebase, you might start to get a little worried here.

What if I stash then pull, but then popping the stash does something that conflicts with the changes I pulled? Can that happen?

Of course it can. Hooray.

When it happens, it looks like this:

```
$ git stash pop
Auto-merging foo.rs
CONFLICT (content): Merge conflict in foo.rs
On branch main
Your branch is up to date with 'origin/main'.

Unmerged paths:
  (use "git restore --staged <file>..." to unstage)
  (use "git add <file>..." to mark resolution)
   both modified:   foo.rs

no changes added to commit (use "git add" and/or "git commit -a")
The stash entry is kept in case you need it again.
```

Sure looks like a merge conflict, and it looks doubly so in the editor.

```

1 fn main() {
2 <<<<<< Updated upstream
3     println!("This is critically fixed");
4     =====
5     println!("This is sorta working");
6 >>>>>> Stashed changes
7 }

```

You can see our stashed changes below where we tried to fix it, but then we see that conflicts with Chris's fix from upstream.

So we do the merge thing and make it *Right*, editing it to look the way we want, and we save it. Our status is still not clean, though.

```

$ git status
On branch main
Your branch is up to date with 'origin/main'.

Unmerged paths:
  (use "git restore --staged <file>..." to unstage)
  (use "git add <file>..." to mark resolution)
    both modified:   foo.rs

no changes added to commit (use "git add" and/or "git commit -a")

```

Let's add it with `git add` to mark it resolved.

A couple things can happen at this point.

1. If you just accepted the pulled version (i.e. discarding your conflicting changes), nothing new will happen. After all, there's already a commit in your repo with their version, so Git is smart enough to just call it a day. `git status` reports clean.
2. If you accepted a version different than the one you pulled (i.e. you kept some or all of your changes), then `git status` will report that file as modified and staged to be committed.

If you're not ready to commit at this point, use `git restore --staged` to unstage the file. That will change it to just be modified and you can work on it more before you commit it.

In both conflict cases the stashed changes are still in the stash! Yes, you ran `stash pop`, but when there's a conflict, the stash remains untouched and doesn't actually pop.

If you're done with it (and you probably are), you can use `git stash drop` to discard the particular stash from the stack and get all cleaned up.

16.4 Stashing New Files

What if you've added a new file to your working tree but it's currently untracked? Can stash see it?

No. You have to add it first. So do a `git add` (but not a commit!) then stash it. The new file should disappear from the working tree.

Chapter 17

GitHub: Forking and Pull Requests

For a lot of projects you're on, maybe you have write permission to the main repo that everyone is using. That is, you've been added as a collaborator and you can just push directly.

If that's the case, you don't need to fork GitHub repos or create pull requests. You can just keep committing and pushing as always.

But what if you want to make changes to a repo on GitHub but you don't have write permission? This might happen if you forked a repo that you want to make changes to. You can write to your fork, but not to the repo you forked from. How do you get the changes you made to your fork into the original repo?

Let's check it out.

A **fork** is a clone of someone else's GitHub repo that you've made on GitHub using their "Fork" command. It's a regular clone except that GitHub is doing some bookkeeping to track which repo you forked from.

The **upstream** is by convention the name of the remote that you forked from. I know this conflicts with some other definitions of "upstream". But for this chapter, in the context of forks, let's assume it means this.

A **pull request** (or "PR" for short) is a way for you to offer changes you've made to your fork to the owner of the original repo.

Forks and Pull Requests are a GitHub thing, not a Git thing. It's some additional functionality that GitHub has implemented on their website that you can use.

Let's say, for example, you found an open source project you liked and there was a bug in it. You don't have permission to write to the project's GitHub repo, so how can you change it?

The process for someone making a pull request is:

1. On GitHub, fork the repo. Now you have your own clone of it.
2. Clone your repo to your local machine. Now you have two clones of it: your fork on GitHub and its clone on your local machine. (And you own them both.)
3. Make the fix on your local machine and test it.
4. Push your fix to your GitHub fork.
5. On GitHub, create a pull request. This informs the upstream owner that you have changes you'd like them to merge.
6. On GitHub, the upstream owner reviews your PR and decides if they want to merge it. If so, they merge it. Otherwise they comment and ask for changes, or delete it.
7. At this point, if you're done, you can optionally delete your fork.

Let's give it a try! Feel free to issue PRs on my sample repo, used below. I'm just going to delete them (they won't be merged); don't take it personally—I just don't have time to review them all.

17.1 Making a Fork

Head on over to my test repo¹ and let's do this:

- In the upper right there should be a button labeled “Fork”. Click it.
- Under “Owner”, choose your user name.
- Under “Repository name”, chose the default or make a new name.
- Optionally, if the repo has multiple branches and you wish to have those in your fork, uncheck the “Copy the main branch only” checkbox. You can always get the branches by hand later if you don't do this.
- Click the “Create fork” button.

This can be done with impunity. That is, you've made your own fork but the original owner is unaware that you did. You can delete it with no damage to the original repo. Remember that a fork is a clone on GitHub that you have ownership of, independent of the original repo.

At this point, you should land on the project page for your fork, and the fine print on the page reads: “forked from beejjorgensen/git-example-repo”.

And now we have our own version of that repo on GitHub to do with as we please.

We can clone it as normal, pull, push, delete the repo, etc. The owner of the original repo will not know about it—our changes affect our repo alone. Later we'll see how to issue a pull request to try to get our changes merged into the original upstream repo.

17.2 Making Your Changes

Let's make some changes. First, we have to clone *our* repo (that is, clone the fork we made) onto our local machine.

So pull down the “Code” button as usual and select the SSH link to clone (or use the GitHub CLI variant if you're using that).

```
$ git clone git@github.com:user/git-example-repo.git
Cloning into 'git-example-repo'...
remote: Enumerating objects: 4, done.
remote: Counting objects: 100% (4/4), done.
remote: Compressing objects: 100% (3/3), done.
remote: Total 4 (delta 0), reused 4 (delta 0), pack-reused 0
Receiving objects: 100% (4/4), done.
```

And then you can `cd` into that directory and see the files there.

```
$ cd git-example-repo
$ ls
hello.py  README.md
```

Let's modify `hello.py` to this:

```
1 #!/usr/bin/env python
2
3 print("Hello, world!")
4 print("This is my program!")
```

¹<https://github.com/beejjorgensen/git-example-repo>

```
5 print("This is my modification")
```

And let's add it, make a commit, and push.

```
$ git add hello.py
$ git commit -m "modified"
 [main 5d3fe49] modified
  1 file changed, 1 insertion(+)
$ git push
Enumerating objects: 5, done.
Counting objects: 100% (5/5), done.
Delta compression using up to 8 threads
Compressing objects: 100% (3/3), done.
Writing objects: 100% (3/3), 1.02 KiB | 1.02 MiB/s, done.
Total 3 (delta 0), reused 0 (delta 0), pack-reused 0 (from 0)
To github.com:user/git-example-repo.git
 4332527..5d3fe49  main -> main
```

Again, this just pushed to our fork, not the upstream. You can look at your fork's page on GitHub and see the change there.

17.3 Syncing the Upstream with Your Fork

Are you ready to make a PR? Hold up just a moment!

What if the upstream owner has made changes to their repo in the meantime? Don't you want to make sure your code works with the latest version of their code?

Of course you do.

On your fork's page, you might have noticed that it has a "Sync fork" button that you can pull down.

If you pull it down and it says "This branch is not behind the upstream", then congratulations! You're already up to date! Go ahead and make a PR, as outlined in the next section.

If you pull it down and it says "This branch is out-of-date" and offers you an "Update branch" button, then congratulations! You're out of date, but you can be brought up to date without a conflict. Click "Update branch" and then go ahead and make a PR, as outlined in the next section. (It might also offer you a "Discard" button, but don't press that unless you want to discard your changes!)

If it instead says "This branch has conflicts that must be resolved", bad news. You have some changes in your repo that conflict with someone else's changes in the upstream. You have some options:

- The UI says you can open a pull request, which will give you a chance to resolve the conflict in-browser as outlined in the next section.
- It also says you can just throw away your changes and replace them with the upstream. Bummer.
- Aside from that, you can actually merge your branch from the upstream on the command line and take care of the conflict there without opening a PR first. See Syncing on the Command Line, below.

In general, it's a good idea to keep in sync with the upstream repo. This way you can be sure your changes aren't conflicting with any upstream changes as you go. It's way better than waiting to resolve them all at the end when you're ready to issue a pull request.

17.4 Making a Pull Request

Now that we’ve modified our fork to our satisfaction, we can ask the upstream maintainer if they’re willing to accept it into the official repo.

Maybe they aren’t ready! Don’t take it personally if they don’t answer or answer with ways they need your patch improved. Work with the owners to get the job done to both of your satisfactions.

Let’s go!

- Click the “Contribute” button and then “Open pull request”.
- Look for the text “This branch has conflicts that must be resolved”. If you find that text, it means the upstream can’t automatically apply your PR and they’ll have to do manual work to make it happen. They’re far more likely to just reject it. To avoid this, you have some options:
 - Don’t open the PR, go back and sync with the upstream, fix the conflict, and try again.
 - Or click the “Resolve conflicts” button right there in the UI and use the in-browser editor to manually resolve.
- Add a nice title.
- Add a good description. You’re asking someone to incorporate your code into their project, so you’ll want to describe what the code does here to make their lives easier when they review it. (Since this example goes to my repo, you can just pretend you wrote something nice—I’m just going to close the PR.)
- Click “Create pull request”!

This lands us on the PR page. You can add more comments or close the request (if you changed your mind about it).

The owner of the upstream will see the PR has been issued, and now you have to wait for a response.

Maybe they respond with a comment asking for improvements or other questions. Maybe they reject the PR and close it, unmerged. Or maybe they accept! Happy days!

17.5 Flipside: Merging a Pull Request

As the upstream owner, if someone issues a PR you’ll be notified (unless you’ve turned those notifications off) with an email and in the notifications in GitHub in the upper right.

When you do, you can visit your project page on GitHub and decide what to do with the PR.

At the top of the project page, you’ll see a “Pull requests” button with a number next to it indicating how many PRs are currently outstanding.

- Click the button to see the list.
- Click on a PR title to get to the PR.

Now we’re looking at the PR. Read the description to see what it does, and then, **very importantly** review the code!

You’re about to accept code from someone you probably don’t know. On this planet, most people are friendly, but that doesn’t mean there aren’t some bad actors (the industry term is *a--holes*) out there looking to take advantage of you by introducing some malicious code. Even if you’ve known the contributor for a year, they might be playing a long game, and if that seems unlikely to you, read about the XZ utils hack that took place in 2024^a.

^ahttps://en.wikipedia.org/wiki/XZ_Utils_backdoor

To review the code, look right below the description to the contributor’s avatar and the commit message. Click on the commit message and you’ll see a diff, as described in the *Comparing Files with Diff* chapter. Lines marked with a + are added, and lines marked with - are removed.

If you just want a straight up view of the file as it was edited by the contributor, you can hit the “...” on the right and then “View file”.

If it’s almost right but you need to make a modification, you can also hit “Edit file” and add commits directly to the PR.

If everything looks good, scroll down and hopefully you’ll see some text that reads “This branch has no conflicts with the base branch” and “Merging can be performed automatically”. This is good news.

If it says that, you can just click “Merge pull request”, and that will add the changes to your repo and close the PR. It’s nice to also add a comment thanking the contributor—they just gave you work for free, after all!

| Closing a PR doesn’t delete the PR. You can still reopen it.

But let’s say the PR does conflict and can’t be automatically merged. GitHub complains that “This branch has conflicts that must be resolved” and gives you some options.

As the upstream owner, you can click the “Resolve conflicts” button and fix the issue if possible.

Or you can just reject the PR and ask the person who opened it to resolve the conflict so that your life might be made easier with an automatic merge.

17.6 Making Many Pull Requests with Branches

Here’s the thing about pull requests: when you make one, it takes all the changes you have on your branch and bundles them together in one. Doesn’t matter if the changes are doing radically different things; they all get rolled into the same PR.

This is sometimes not so great from an administrative perspective. Maybe I want a PR for issue #1 and a different PR for issue #2!

The way to make this happen is to make a local branch on the clone of your fork for each individual PR, and push those branches to your fork. Then when you create the PR, you choose the branch to use. Even if your branch is named something like `feature1`, you can still merge it into the `main` branch on the upstream.

So make a new branch for the feature:

```
$ git switch -c feature1
Switched to a new branch 'feature1'
```

Then make your changes, add, and commit.

```
$ vim readme.txt
$ git add readme.txt
$ git commit -m "feature 1"
[feature1 1ad9e92] feature 1
1 file changed, 1 insertion(+)
```

Then push them to your repo, setting up a remote-tracking branch:

```
$ git push -u origin feature1
Enumerating objects: 5, done.
Counting objects: 100% (5/5), done.
Delta compression using up to 8 threads
Compressing objects: 100% (2/2), done.
Writing objects: 100% (3/3), 979 bytes | 979.00 KiB/s, done.
Total 3 (delta 1), reused 0 (delta 0), pack-reused 0 (from 0)
```

```

remote: Resolving deltas: 100% (1/1), completed with 1 local
remote: object.
remote:
remote: Create a pull request for 'feature1' on GitHub by
remote: visiting:
remote:   https://github.com/user/fork/pull/new/feature1
remote:
To github.com:user/fork.git
 * [new branch]      feature1 -> feature1
branch 'feature1' set up to track 'origin/feature1'.

```

Now you can jump back to GitHub and issue a PR. (And look at the response from the remote helpfully telling you the GitHub URL to visit to issue the PR!)

In the GitHub UI, there might be a handy little popup there saying “feature1 had recent pushes 4 minutes ago” and a button “Compare and pull request” you can click to make the PR.

But if it’s been too long and the popup is gone, not to worry. See the branch selector button on the upper left that probably says “main” right now? Pull it down and select the branch “feature1” that you want to create the PR for. Then click “Contribute” and open the PR.

There’s a line at the top of the PR that indicates the repo and branch that will be merged into, and, on the right, your repo and branch name that you’ll be merging from.

The rest of the PR proceeds as normal.

Don’t delete your branch until after the merge! Once it has been safely merged, GitHub will pop up a “Delete branch” button for you on the PR page. This will delete the branch on GitHub, but you’ll still have to delete `feature1` and `origin/feature1` on the command line.

17.7 Deleting a Pull Request

Short answer: you can’t.

Long answer: you can.

The irony is that the short answer is longer. I don’t make the rules.

Proper long answer: you can if you are the upstream owner and the PR contains sensitive information.

There’s no way in the UI to delete PRs, whether you’re the forker or forkee. And this can be a bummer especially if you’ve accidentally included some sensitive information like social security number 078-05-1120².

But hope is not all lost! The upstream owner can visit the virtual assistant at GitHub and ask for a pull request removal³ which apparently works. I haven’t tried it.

If there’s a way as the forker to delete the PR they created, I haven’t seen it. You’ll have to plead your case with the upstream owner and get them to do it.

In any case, you most definitely should change your leaked credentials right now and let that be a lesson to you.

²https://en.wikipedia.org/wiki/Social_Security_number#SSNs_used_in_advertising

³<https://support.github.com/request?q=pull+request+removals>

17.8 Syncing on the Command Line

GitHub has that nice Sync button to bring the upstream changes into your fork, and this was a welcome addition. It used to be you had to do it the hard way.

But the hard way has an additional benefit: if the upstream conflicts with your changes, you can merge them locally before creating the PR. The GitHub UI requires you create a PR to resolve the conflict.

Additionally, if you just like the command line and want to quickly sync the upstream to your branch, this can do it.

The plan is this:

1. Add an `upstream` remote that points to the upstream repo.
2. Fetch the data from `upstream`.
3. Merge the upstream branch into your branch.
4. Resolve conflicts.
5. Push your branch.
6. Go issue a now-hopefully-non-conflicting PR.

Let's try. I'll be on my `main` branch, and try to sync it with the upstream's `main` branch. I'll show what it's like when there's a conflict. (If there were no conflict, the merge would succeed automatically.)

First things first: if you haven't already, set up the `upstream` remote to point to the original owner's repo. This is the repo that you forked from. Since you won't be pushing to it, you can use the SSH or HTTP methods to access it. (And this remote can be named anything, but `upstream` is a common convention.)

```
$ git remote add upstream https://github.com/other/orig-repo.git
```

And then we need to get the new commits from the upstream repo and merge them into our stuff.

```
$ git fetch upstream
remote: Enumerating objects: 5, done.
remote: Counting objects: 100% (5/5), done.
remote: Compressing objects: 100% (1/1), done.
remote: Total 3 (delta 1), reused 3 (delta 1), pack-reused 0
Unpacking objects: 100% (3/3), 950 bytes | 950.00 KiB/s, done.
From https://github.com/other/upstream
 * [new branch]      main      -> upstream/main

$ git switch main # Make sure we're on the main branch

$ git merge upstream/main
Auto-merging readme.txt
CONFLICT (content): Merge conflict in readme.txt
Automatic merge failed; fix conflicts and then commit the result.
```

(You could also rebase if you wanted.)

At this point, we should edit the file and resolve the conflict, and complete the resolution as per usual.

And then we push back to our fork on GitHub!

```
$ git push
Enumerating objects: 7, done.
Counting objects: 100% (7/7), done.
Delta compression using up to 8 threads
```

```
Compressing objects: 100% (2/2), done.  
Writing objects: 100% (3/3), 999 bytes | 999.00 KiB/s, done.  
Total 3 (delta 1), reused 0 (delta 0), pack-reused 0 (from 0)  
remote: Resolving deltas: 100% (1/1), completed with 1 local  
remote: object.  
To github.com:user/fork.git  
8b2476c..c8a7e0a main -> main
```

If we jump back to the GitHub UI at this point and open a PR, it should tell us “These branches can be automatically merged” which is music to everyone’s ears.

Once you have the `upstream` remote set up, all you have to do to sync in the future is do the `git fetch upstream` and then merge or rebase your stuff with it.

Chapter 18

Reverting: Undoing Commits

Let's say you made some changes and committed them, but they actually botched everything up. You want to just revert to an earlier version of the file.

There's the cheesy way to do this that might have already occurred to you: detach the head to an earlier commit where the file was like you wanted it, make a copy of the file someplace safe, then reattach the head to `main`, then copy the old file over the existing one in your working tree. And add and commit! And this would work...

But let's be more proper, and we can do that with `git revert`.

Reverting allows us to actually undo the changes of a single commit, even if it wasn't the one that got you to the point you're at now. That is, let's say you've made 30 commits, but it turns out you don't actually want commit number 4 to be there any longer. You can revert just that one!

Performing a standard revert will actually make a new commit, and doesn't erase any old commits. In this way, it's not rewriting history so using this method is safe to revert commits that have already been pushed.

18.1 Performing the Revert

It's pretty straightforward. You look back in the log for the commit ID you're interested in reverting, and revert it.

For example, if you have this in the log:

```
commit 9fef4fe6d42b91c12b5217829e8d98d738f84d61
Author: Brian "Beej Jorgensen" Hall <beej@beej.us>
Date:   Fri Jul 26 16:59:44 2024 -0700

    Added Line 50
```

and you decided you didn't want that commit any longer, you could revert it by its commit ID. Here I'll just type the first few characters of the hash because that's enough:

```
$ git revert 9fef4
Auto-merging foo.txt
[main de415f4] Revert "Added Line 50"
 1 file changed, 1 deletion(-)
```

There's no conflict (more on that, below) in this example, so it just pops me into my editor and allows me to edit the commit message. Remember that the revert makes a new commit!

```

1 Revert "Added Line 50"
2
3 This reverts commit 9fef4fe6d42b91c12b5217829e8d98d738f84d61.

```

I save the file and `git status` tells me we're clean.

Another `git log` will show the revert commit:

```

$ git log
commit de415f4f0cd645b1e551a6ac56e13f73850c88db (HEAD -> main)
Author: Brian "Beej Jorgensen" Hall <beej@beej.us>
Date:   Fri Jul 26 17:01:54 2024 -0700

    Revert "Added Line 50"

    This reverts commit 9fef4fe6d42b91c12b5217829e8d98d738f84d61.

```

You can revert any commit, even commits that were themselves reverts! Revert the revert!

Now that was an example where the revert went smoothly. But what if you've made some changes since the revert commit that were close to the changes in the revert commit itself? Can it conflict? Of course it can!

18.2 Revert Conflicts

Like with merging or rebasing, you can have conflicts with a revert. If you're not familiar with conflict resolution, please review the Rebasing Conflicts section, because it's closest to how revert conflicts work.

An example of a conflict might be that if you changed line 37 in your code, then revert a commit that also changed line 37 in the code, Git can't figure out what to do with that. Should it revert it to what it was before your commit, or before the earlier commit?

So there's a revert conflict that must be resolved. And it works very much like the other conflicts we've already seen.

If you try to revert and get a conflict, it will say something like this:

```

$ git revert 5af89a8985c001ec02409d77e093fb7be45495ff
Auto-merging foo.txt
CONFLICT (content): Merge conflict in foo.txt
error: could not revert 5af89a8... Added Line 69
hint: After resolving the conflicts, mark them with
hint: "git add/rm <paths>", then run
hint: "git revert --continue".
hint: You can instead skip this commit with "git revert --skip".
hint: To abort and get back to the state before "git revert",
hint: run "git revert --abort".
hint: Disable this message with
hint: "git config advice.mergeConflict false"

```

And it points out we have a few options here. We can get even more info with our friend `git status`:

```

$ git status
On branch main
You are currently reverting commit 5af89a8.
  (fix conflicts and run "git revert --continue")
  (use "git revert --skip" to skip this patch)
  (use "git revert --abort" to cancel the revert operation)

Unmerged paths:
  (use "git restore --staged <file>..." to unstage)
  (use "git add <file>..." to mark resolution)
    both modified:   foo.txt

no changes added to commit (use "git add" and/or "git commit -a")

```

So what we can do here is one of these:

- Edit the file, fix the conflict, then `git add` it, then `git revert --continue` to go to the next commit to be reverted (if any).
- Bail out completely with `git revert --abort`.
- Skip reverting this particular commit with `git revert --skip`. If you skip all the commits you were reverting, it's just like an abort.

If you fix the conflict, you'll get to enter a commit message for the new commit just like before.

18.3 Reverting Multiple Commits

You can specify multiple reverts at the same time on the command line.

Here's an example that reverts two commits:

```

$ git revert 4c0b3 81d2a
Auto-merging foo.txt
[main ab3169d] Revert "Added Line 50"
 1 file changed, 1 deletion(-)
Auto-merging foo.txt
[main b63f003] Revert "Added Line 10"
 1 file changed, 1 deletion(-)

```

And there will be two new revert commits after that. You'll edit two revert commit messages over the course of that revert.

You can also specify a range of commits. Be sure to do this in oldest-to-newest order, or you'll get an empty commit set passed error.

```

$ git revert 4c0b3^..81d2a
Auto-merging foo.txt
[main ab3169d] Revert "Added Line 50"
 1 file changed, 1 deletion(-)
Auto-merging foo.txt
[main b63f003] Revert "Added Line 10"
 1 file changed, 1 deletion(-)

```

Again, that will make a lot of commits, one per revert. You can squash those commits if you want to, or you can use `-n` ("no commit") to keep Git from committing until you're ready.

```
$ git revert -n ee71e 123e8
Auto-merging foo.txt
Auto-merging foo.txt
```

At this point, the file is staged with those two commits reverted. And you can now make a single commit that holds them. And you can do the same thing specifying a range.

Of course, there might a conflict, and you'll have to resolve those in the super fun way we've already discussed.

Chapter 19

Reset: Moving Branches Around

Before we begin, using `git reset` *rewrites history*. This means that you shouldn't use it on any branches that other people might have copies of, i.e. branches that you have pushed.

Of course, this is a highly-recommended guideline, not a rule, and you can reset anything provided you know what you're doing and have good communication with your team.

But if you never reset a branch you haven't pushed, you won't get into trouble.

So what is it?

Doing a reset allows you change where the HEAD and your current branch point to. You can move your current branch to a different commit!

When you move a branch to another commit, the branch “becomes” the repo at the point of that commit, including all the history that led up to that commit. The upshot is that all the commits that led to the old branch point are now effectively gone, as shown in Figure 18.1.

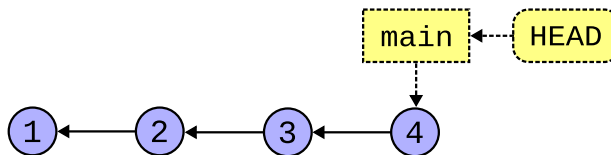

Figure 19.1: If we reset `main` to commit 2, commits 3 and 4 will eventually be lost.

So be sure you mean it when you reset! You'll be losing commits¹!

When doing a reset, you can ask Git to move the current branch to another commit, or to another branch, or to anything else that identifies a commit.

Now, there is a question of what happens to the *difference* between your working tree at the old commit and whatever it would be at the new commit.

You might have read that last sentence too quickly, so let's revisit it because it's important. Right now, you have some files in your working tree. Let's assume you're fully committed and your HEAD is on the `main` branch. Now if you move the `main` branch elsewhere, *there will necessarily be a difference between what you had at the commit you were looking at, and the one you will be *looking at.*

We need to decide what to do with that difference. Where will it be reflected? As a difference between the stage and the destination commit? A difference between the working tree and the stage? Or both?

¹Git cleans up “unreachable” commits after some time has elapsed, so they won't be *instantly* destroyed. But they're on borrowed time unless you create a new branch to hold them.

Turns out we have three options: **soft reset**, **mixed reset**, and **hard reset**.

And which you choose controls what happens to the branch, the stage, and the working tree.

I want you to consider that all files exist in three places at all times in Git: the working tree, the stage, and a commit.

And you're supposed to say, "Wait—the stage has *all* the files on it? But I haven't added anything to it!"

Yes. I'm saying that when your working tree is clean that means that the files in the `HEAD` commit, the files on the stage, and the files in your working tree *are all the same*. And, yes, all the files exist in all three places!^a

And `git status` won't show anything because there are no differences between these three places. And `git status` shows the differences.

Let's say you modified a file in your working tree. In that case, `git status` would show you a difference between your working tree and the stage as a "modified file". But there would still be no difference between the stage and the `HEAD` commit, so nothing would show as "ready to commit".

Then let's say you added the file to the stage. At the point, a copy of the file from the working tree is placed on the stage. So now the working tree and the stage are the same. And nothing shows as "modified". But now, crucially, the stage differs from the `HEAD` commit! So now `git status` shows that difference as "ready to commit".

Finally, let's say that before you committed, you modified the file again in the working tree. Now the file in the working tree is different than the stage. **And** the file on the stage is different than the `HEAD` commit! Now the file shows up as both "ready to commit" and "modified".

The reason I want us to think about things this way is because it will make this whole thing with `git reset` easier to digest. Sometimes a reset will change the files in the working tree, sometimes on the stage, and sometimes both.

^aWho knows what it really does under the hood, but we're going to use this as a mental model for how things work.

Note: in the following examples, I'm going to use the term "old commit" to refer to where the branch was *before* the reset, and "new commit" to refer to where it will be *after* the reset.

With all three variants, the current branch moves to the new (specified) commit.

The summary of differences is:

- **Soft:**
 - Stage: old commit
 - Working tree: old commit
 - Result: All the old files will show on the stage as "ready to commit".
- **Mixed:**
 - Stage: new commit
 - Working tree: old commit
 - Result: All the old files will show in the working tree as "modified".
- **Hard:**
 - Stage: new commit
 - Working tree: new commit
 - Result: All the old files will be gone, and the working tree and stage will be clean.

19.1 Soft Reset

When you run a `git reset --soft`, this resets the current branch to point to the given commit, and makes the stage and working tree both have the changes that were present in the old commit.

The upshot is that `git status` will show your old commit's changes as staged, and none of the files as modified.

In other words, you'll see the old state of your files on the stage ready to commit.

A common use for this might be to collapse some of your previous commits similar to what we did with rebase and squashing commits.

Let's say we have commits like this (pretend the numbers are the commit hashes):

```
commit 555 (HEAD -> main)
  Fixed another typo again
commit 444
  Fixed another typo
commit 333
  Fixed a typo
commit 222
  Implemented feature
commit 111
  Added
```

That's a gnarly-looking commit history. It would be nice to rewrite it (*but if and only if you haven't pushed it yet!*).

We can do that with a soft reset back to commit `111`.

If we do this soft reset:

```
$ git reset --soft 111 # Again, pretend 111 is the commit hash
```

We'll then be in this point with all the other commits gone...

```
commit 111 (HEAD -> main)
  Added
```

Except importantly our files *as they existed in commit 555* will now be staged and ready to commit. That means with the soft reset the changes weren't lost, but effectively commits 222-555 are all squished together on the stage.

So we commit them:

```
$ git commit -m "Implemented feature"
```

And now we're here with a nice commit history:

```
commit 222 (HEAD -> main)
  Implemented feature
commit 111
  Added
```

And now, finally we can push, happy that our changes are presentable to the general public.

Again, we've rewritten history here. Don't do this if you've already pushed those commits past the one you're resetting to.

19.2 Mixed Reset

Before we begin, the main use case of this reset was to unstage files. Now the more modern command is `git restore --staged`, and you should use that if all you want to do is unstage.

But let's still look at how this works!

When you run a `git reset --mixed`², this resets the current branch to point to the given commit, and it modifies the stage to that commit, and it **doesn't** change your working tree.

The upshot is that it will show files as “modified” with the changes of the old commit, and there will be nothing on the stage.

Now, thinking about this, since the branch has moved to a commit with your files in one state, but your working tree has the files in another state, the files must be *modified* with respect to the commit the branch now points to.

And this is what happens. Your changes at the old commit will show up as modified files at the current commit.

It's like the soft reset, except instead of the old commit ending up on the stage, it ends up in the working tree. You can stage it and commit it from here.

But that's not all! Since the stage is also updated to the new commit, it means the stage is effectively “emptied”.

Like I mentioned, this is the classic use for a mixed reset: `git reset HEAD`. This moves files from staged state back to modified state.

This will reset the current branch to where it already was (assuming `HEAD` points to the current branch), and reset the stage to be the same as that commit. This unstages the files that were there. And it changes the working tree files to have the changes that were already present in those files at that point, which would be any changes you introduced.

And that unstages the files!

Another use might be if you want to squash a bunch of unpushed commits but simply don't want to stage the changes at the old commit yet, leaving them as modified.

19.3 Hard Reset

This resets everything to a particular commit. The branch moves there. The stage is set to that commit. The files in the working tree are set to that commit. All changes since that commit are lost.

Use this if you want to bail out. You've made some commits and decided that was the wrong way, and you want to just roll them back entirely.

Again, only do this if you haven't pushed!

If you do a hard reset, it will simply move the branch and reset your entire world (as it pertains to that branch) to that point as if nothing had happened since. `git status` will report that everything is clean.

19.4 Reset to a Divergent Branch

In the above examples, we've been resetting to a direct ancestor of our current commit. This is the common case for using `git reset`.

But there's no reason why you couldn't reset to an entirely different divergent branch. It just moves the branch there with exactly the same rules for soft, mixed, and hard that we've already covered.

²You can leave off the `--mixed` since it's the default.

19.5 Resetting Files

So far, we've been just doing resets on a commit-by-commit basis. But we could also do mixed resets with specific files. We can't do hard or soft resets with specific files, though—sorry!

For example, we can do a mixed reset to unstage a single file.

Let's say we're here:

```
$ git status
On branch main
Changes to be committed:
  (use "git restore --staged <file>..." to unstage)
   modified:   bar.txt
   modified:   foo.txt
```

And we want to reset `foo.txt` off the stage, but leave `bar.txt` on there.

Again, we'd use `git restore --staged` in these modern times. But we're going to press on here for the sake of example.

So let's specify just that file:

```
$ git reset foo.txt
Unstaged changes after reset:
M   foo.txt

$ git status
On branch main
Changes to be committed:
  (use "git restore --staged <file>..." to unstage)
   modified:   bar.txt

Changes not staged for commit:
  (use "git add <file>..." to update what will be committed)
  (use "git restore <file>..." to discard changes in working
 directory)
   modified:   foo.txt
```

And there you have it.

19.6 Pushing Branch Changes to a Remote

Let's say you've made a mess of things somehow and you have to reset a branch that you've already pushed commits on. That is, you have to rewrite a public history.

First: *get good communication with the team.* They're going to make fun of you for sure, but at least they won't hate you³.

Never do a forced push without completely understanding why you're doing it. Git is trying to stop you from doing a push for a reason: your own good! Everyone else who has cloned the repo will very likely be impacted and they need to be informed. Everybody. We use it here to demonstrate when it is necessary.

Our process will be something like this:

³No guarantees. You shouldn't rewrite commit history that is already public!! It makes a big mess!

1. Do the reset.
2. Do a forced push to your remote. For your protection, Git won't push in this circumstance. You have to override with a forced push.

Your coworkers will do something like this:

1. Do a `git fetch` to get the new branch position from the remote.
2. Stash or commit any local changes they need to preserve.
3. Maybe make a new branch at the old branch point in case they need to return to see old soon-to-be-obiterated commits.
4. Do a reset of the branch in question to the remote branch commit. For example, if we're resetting the `main` branch, you would `git reset --hard origin/main`.
5. Pop their changes from the stash, if any.
6. Maybe apply earlier commits that got obliterated⁴.

Note that your coworkers don't necessarily need to do a hard reset; they could do a mixed reset, for instance.

19.6.1 Forcing the Push

We have basically two options to use with `git push` here:

1. `--force`: Just push the new branch position, damn the torpedoes⁵.
2. `--force-with-lease`: Only force push if the remote branch's position is what we expect. In other words, **don't** force push if someone else has pushed a new commit in the meantime. This is a good safety measure because no one should have pushed a new commit in the meantime since you've been in communication with your team about this. **Right?**

If you try to `--force-with-lease` and someone else has pushed another commit to this branch in the meantime, you'll be presented with an error:

```
$ git push --force-with-lease
To git@github.com:user/repo.git
 ! [rejected]          main -> main (stale info)
error: failed to push some refs to 'git@github.com:user/repo.git'
```

If that happens, you'll have to talk to your team to get them to stop, and then pull the changes, make sure everyone is on board with the new reset, and then start again.

We'll use `--force-with-lease` in our examples.

19.6.2 Example: Rewrite Public History

First, let's play the part of the person who is rewriting the public history.

The very first thing I'm going to do is coordinate with the team. If you're already past this point, do it **right now**.

Then we'll start the rewrite. We'll be on the `main` branch for this demo. Let's reset to an earlier commit, and we'll assume that these commits we're resetting past are already public and other team members already have them.

```
$ git reset --hard 4849e6
HEAD is now at 4849e65 added line 3
```

⁴Perhaps using `git reflog` and `git cherry-pick` or `git cherry-pick -n` and potentially `git add -p`, all of which are covered in later chapters. Along with judicious use of `rebase`, old commits or parts of old commits can be applied while keeping the commit history clean.

⁵https://en.wikipedia.org/wiki/Battle_of_Mobile_Bay#%22Damn_the_torpedoes%22

So far no harm, but now we're going to push this history change to our origin. And we'll use `--force-with-lease` for safety.

```
$ git push --force-with-lease
To git@github.com:user/repo.git
+ a2b7ac3...ce44516 main -> main (forced update)
```

Now we've publicly rewritten history. Tell the team, which you've been in contact with this entire time, that you've done so. And they can begin to fix up their clones with much grumbling.

19.6.3 Example: Receiving Rewritten History

You've just received word from your coworker that public history on the `main` branch has been rewritten and pushed to the remote, which we'll assume is `origin` for this example.

First thing we should do is make sure we're all backed up in whatever manner we need.

Perhaps a commit of the latest stuff:

```
$ git add [all files]
$ git commit -m "last commit before public reset"
```

Or a stash if we're not ready to commit:

```
$ git stash
```

And perhaps make a new branch right here so we can revisit the old state of affairs for reference if we have to:

```
$ git branch oldmain
```

And now it's time for action. We need to fetch the new branch information.

```
$ git fetch origin
From git@github.com:user/repo.git
+ e7b133a...521a873 main -> origin/main (forced update)
```

We just fetched, so our clone doesn't look different to us yet. But let's put an end to that and get on the same page as `origin`. This involves resetting our local `main` to be the same as it is on the remote tracking branch `origin/main`. (Remember the latter has been force pushed to a different commit, and we want our `main` to point to that commit, as well.)

Assuming we're on branch `main` right now:

```
$ git reset --hard origin/main
```

And now we're on the same page as `origin`.

If we had stashed things, let's try to get them back, resolving any conflicts as per usual:

```
$ git stash pop
```

And if you want to refer to any old commits and you set up the `oldmain` branch as above, you can `git switch oldmain` to examine them, and maybe use something like `git cherry-pick` to bring in any functionality you need.

19.7 Resetting Without Moving HEAD

Using the reset feature moves the HEAD around by necessity. What if you just want to move a branch to another commit but leave HEAD alone?

It can be done! But you can't do it with a branch you have checked out right now. So either detach the head or attach it to a different branch.

Instead of using `git reset` to do this, we'll use `git branch`. Here's an example:

```
$ git switch topic1
Switched to branch 'topic1'

$ git log
commit 97c4da49eda8de7b273003515a660945c (HEAD -> topic1)
Author: User <user@example.com>
Date: Thu Aug 1 14:22:39 2024 -0700

    fix a third typo

$ git branch --force main
$ git log
commit 97c4da49eda8de7b273003515a660945c (HEAD -> topic1, main)
Author: User <user@example.com>
Date: Thu Aug 1 14:22:39 2024 -0700

    fix a third typo
```

See what happened to `main`? It moved to the current commit! You can see it in the output for the second `git log`.

You could also specify a destination for `main` as a second argument if you wanted it to move somewhere other than your current location.

19.8 Resetting to Remove Credentials

Did you accidentally commit some secret password into your repo? Can you use `git reset` to back out of that commit?

- Have you pushed? Then **NO**. Your password is out in the wild. Change it now and never make that mistake again.
- Have you *not yet* pushed? **Yes**. You can do it. But keep in mind the commit containing the password will remain in your local repo until it is garbage collected.

If the answer was yes, you might find `git reset -p` useful to selectively reset parts of commits, something we'll cover in a later chapter.

Chapter 20

The Reference Log, “reflog”

All this time you’ve been committing things, branching, doing whatever. And Git’s been watching you, listening like Big Brother, recording everything you do.

And you can use this to your benefit.

Let’s say you’ve done something like a hard reset because you wanted to abandon the branch you were on.

But then, wait! You actually needed something from one of those commits you just reset past! Is there any way to get back to it? There’s no branch there, and you can’t remember the commit ID. And since it’s not an ancestor to anything, `git log` won’t help you.

How can you get it back?

`git reflog` to the rescue!

The reflog contains a record of all manner of things you’ve done along with commit IDs, and it keeps them for 90 days¹. After that time, orphan commits (that is commits with no branch above them) will be garbage collected.

20.1 What Can We Use It For?

You can use it for all kinds of things.

- Looking at orphan commits
- Recreating deleted branches
- Recovering from a bad reset
- Exploring the order of operations on the repo, even if they’re on other branches
- And more!

Basically it gives you a way to look back on the linear history of the repo, and tells you the commit hashes along the way.

This means if you want to, say, hard reset the repo to some earlier state, you could look up that earlier commit in the reflog².

20.2 Looking Back at an Orphan Commit

Let’s run an example where we do the following:

¹By default it’s 90 days. You can configure this with the `gc.reflogExpire` config option.

²Keeping in mind to never rewrite history on anything you’ve pushed, of course.

1. Commit a file, `foo.txt`, on the `main` branch.
2. Make a new branch, `topic1`.
3. In this new branch, add another file, `bar.txt`, and commit it.
4. Modify `bar.txt` and commit the modification.
5. Decide, at this point, you’re giving up on `topic1`. Switch back to the `main` branch and force delete `topic1`.
6. Decide, at this point, that actually you need to look back at that commit in `topic1` for some reason. But you deleted the branch. Whoops.
7. Look in the reflog for the commit on `topic1` that you want.
8. Switch to that commit (detaching the `HEAD`).

And here that is in Git, at least the first five steps:

```
$ echo 'Line 1' > foo.txt           # Create foo.txt
$ git add foo.txt
$ git commit -m 'added foo.txt'
[main (root-commit) 90bd7cc] added foo.txt
 1 file changed, 1 insertion($)
 create mode 100644 foo.txt
$ git switch -c topic1             # Switch to topic1
Switched to a new branch 'topic1'
$ echo 'Line 1' > bar.txt           # Create bar.txt
$ git add bar.txt
$ git commit -m 'added bar.txt'
[topic1 4219f83] added bar.txt
 1 file changed, 1 insertion($)
 create mode 100644 bar.txt
$ echo 'Line 2' >> bar.txt          # Modify bar.txt
$ git add bar.txt
$ git commit -m 'appended to bar.txt'
[topic1 bf8b8cf] appended to bar.txt
 1 file changed, 1 insertion($)
$ git switch -                     # Switch back to main
Switched to branch 'main'
$ git branch -D topic1             # Delete topic1
Deleted branch topic1 (was bf8b8cf).
```

At this point let’s say we want to look back at the commits we made on `bar.txt`. Good luck with `git log`!

```
$ git log
commit 90bd7cc6c3c530798872827ba02cb7db4fd422c2 (HEAD -> main)
Author: User <user@example.com>
Date:   Fri Oct 4 16:24:56 2024 -0700

    added foo.txt
```

That’s it? Where’s all the `bar.txt` stuff? Well, it was on the `topic1` commits, which were descendants from this commit `90bd7`. Because `git log` only shows ancestors, we’re not seeing any of the `bar.txt` changes.

So, finally, we arrive at the entire topic of this chapter: the reflog. Let’s take a peek.

```
$ git reflog
90bd7cc (HEAD -> main) HEAD@{0}: checkout: moving from topic1 to
main
```

```
bf8b8cf HEAD@{1}: commit: appended to bar.txt
4219f83 HEAD@{2}: commit: added bar.txt
90bd7cc (HEAD -> main) HEAD@{3}: checkout: moving from main to
    topic1
90bd7cc (HEAD -> main) HEAD@{4}: commit (initial): added foo.txt
```

Hey, that’s more like it! I see the changes I made to `bar.txt` in there! And I see the commit hash on the left! This means I can switch to that commit!

```
$ git switch --detach bf8b8cf
HEAD is now at bf8b8cf appended to bar.txt
$ git log
commit bf8b8cf826bbf667cdd088cfcecbc1086c24de3b (HEAD)
Author: Brian "Beej Jorgensen" Hall <beej@beej.us>
Date:   Fri Oct 4 16:24:56 2024 -0700

    appended to bar.txt

commit 4219f83f22f8a90cb8d57128501facb58b292003
Author: Brian "Beej Jorgensen" Hall <beej@beej.us>
Date:   Fri Oct 4 16:24:56 2024 -0700

    added bar.txt

commit 90bd7cc6c3c530798872827ba02cb7db4fd422c2 (main)
Author: Brian "Beej Jorgensen" Hall <beej@beej.us>
Date:   Fri Oct 4 16:24:56 2024 -0700

    added foo.txt
```

There’s the log... and we have the file contents?

```
$ cat bar.txt
Line 1
Line 2
```

Yup!

Let’s switch back to `main` and see what happens.

```
$ git switch -
Warning: you are leaving 2 commits behind, not connected to
any of your branches:

    bf8b8cf appended to bar.txt
    4219f83 added bar.txt

If you want to keep them by creating a new branch, this may be a good
time to do so with:

    git branch <new-branch-name> bf8b8cf

Switched to branch 'main'
```

This is Git telling us, “Hey, I’m going to garbage collect these two commits after the 90 days are up. If you want to keep them, attach a branch to them.”

And it’s helpfully telling us how to do that.

So even though we force deleted `topic1` earlier, we could now simply recreate it if we didn’t mean to do that. Let’s do that.

```
$ git branch topic1 bf8b8cf
$ git switch topic1
  Switched to branch 'topic1'
$ cat bar.txt
  Line 1
  Line 2
```

As you can see, the reflog can get you out of all kinds of trouble when you thought you’d lost commits for good.

20.3 Reflog Selectors

Let’s take a look at that example reflog output again:

```
$ git reflog
598c84e (HEAD -> main) HEAD@{0}: checkout: moving from topic1 to
                                     main
dc3d6a3 HEAD@{1}: commit: appended to bar.txt
0789880 HEAD@{2}: commit: added bar.txt
598c84e (HEAD -> main) HEAD@{3}: checkout: moving from main to
                                     topic1
598c84e (HEAD -> main) HEAD@{4}: commit (initial): added foo.txt
```

See that `HEAD@{3}`-type stuff in there? You can use those to check out specific commits (instead of using the commit hash, for example).

Now, `HEAD@{3}` **doesn’t** mean “3 commits before `HEAD`”. But it is an identifier you can use to switch to a particular commit.

```
$ git switch --detach HEAD@{1}
  HEAD is now at dc3d6a3 appended to bar.txt
```

Just like that.

Chapter 21

Patch Mode: Applying Partial Changes

A lot of Git commands obey the `-p` switch that puts them in *patch mode*. This is a powerful mode that allows you to select *some* of the changes for a particular command, but not *all* of the changes.

Commands that use `-p` include `add`, `reset`, `stash`, `restore`, `commit`, and more.

Basically any time you have changes to a file and you're thinking, "I want to do something with just *some* of these changes", patch mode will help you out.

Some terminology: Git calls a collection of close changes a *hunk*. An example might be if you modified function `foo()` by adding a few lines and modified function `bar()` by adding a few lines, you would likely have two hunks, one for each group of changes.

Patch mode allows you to select which hunks will be operated on.

21.1 Adding Files in Patch Mode

Let's say you had a commit that added `Line 1` to `Line 8` in a file:

```
Line 1
Line 2
Line 3
Line 4
Line 5
Line 6
Line 7
Line 8
```

And we make a couple changes, adding a line to the top and bottom:

```
Line BEGIN
Line 1
Line 2
Line 3
Line 4
Line 5
Line 6
Line 7
Line 8
```

```
Line END
```

And I'm about to add and commit, but I realize that I only want to add `Line BEGIN` at this time, and not `Line END`.

If I did a regular `git add`, it would add both changes to the stage. But if I do `git add -p`, we can select one or the other. Let's try it.

First let's have a look at our diff.

```
$ git diff
diff --git a/foo.txt b/foo.txt
index a982fdc..125f6ac 100644
--- a/foo.txt
+++ b/foo.txt
@@ -1,3 +1,4 @@
+Line BEGIN
  Line 1
  Line 2
  Line 3
@@ -6,3 +7,4 @@ Line 5
  Line 6
  Line 7
  Line 8
+Line END
```

Poring over that, you see we've added `Line BEGIN` to the top and `Line END` to the bottom. (Recall that lines with `+` in front of them are additions in diff.)

Now let's do a patch add.

```
$ git add -p
diff --git a/foo.txt b/foo.txt
index a982fdc..125f6ac 100644
--- a/foo.txt
+++ b/foo.txt
@@ -1,3 +1,4 @@
+Line BEGIN
  Line 1
  Line 2
  Line 3
(1/2) Stage this hunk [y,n,q,a,d,j,J,g,/,e,p,]?
```

Well, that's a lot of options! The easy ones are `y` for "yes" and `n` for "no". And also you can type `?` to get more detailed help.

Also we see that this is hunk 1 of 2, which makes sense because we have one change at the top of the file and another at the bottom.

In our case, we do want to keep this first hunk, so we'll answer `y`.

And then we get to hunk 2 of 2:

```
(1/2) Stage this hunk [y,n,q,a,d,j,J,g,/,e,p,]? y
@@ -6,3 +7,4 @@ Line 5
```

```

Line 6
Line 7
Line 8
+Line END
(2/2) Stage this hunk [y,n,q,a,d,K,g,/,e,p,?]?

```

And for this one, I'm going to say `n` to not stage it. Then we're back out to the shell prompt.

Now I'm going to type `git status` to see where we are, but first I want you to think about what it's going to tell us.

We have one of the changes staged, and the other change not staged. What state are files in when they have unstaged changes? And when there are staged changes? We have both right now, right?

```

$ git status
On branch main
Changes to be committed:
  (use "git restore --staged <file>..." to unstage)
    modified:   foo.txt

Changes not staged for commit:
  (use "git add <file>..." to update what will be committed)
  (use "git restore <file>..." to discard changes in working directory)
    modified:   foo.txt

```

Sure enough! Because we only did a partial add of the changes in the file, the added changes are on the stage, and the not-added changes are still out in the working directory. It *has* to be this way because we haven't staged *all* our changes!

At this point we can go ahead and commit the partially-added changes that are on the stage.

21.2 Resetting Files in Patch Mode

Kind of the opposite of `git add -p` is `git reset -p`. You can use `reset -p` to selectively change hunks *on the stage*.

It's that last part that makes it a bit weird, but you can think of `add -p` as selectively adding hunks to the stage from the working tree, and `reset -p` as selectively removing hunks from the stage relative to a particular commit.

That is, I can reset to an earlier commit, but choose what hunks to reset.

This is not a hard, soft, or mixed reset. It's its own thing. If you try to specify a certain type of reset in addition to `-p`, Git will complain. Arguably this should be a different command entirely, but that's Git for ya!

Let's say I have two commits. In the first one, I added `Line 1` through `Line 8`, and in the second commit I added `Line BEGIN` and `Line END`, just like in the earlier example.

But now I decide I want to reset the `Line END`, but it's part of another commit. I can break it out with `git reset -p`. Let's do it.

Here's my log:

```

commit d2d5899a253d5ce277d4d5981d03a43e68da6677 (HEAD -> main)
Author: User Name <user@example.com>

```

```
Date:   Fri Oct 11 16:12:26 2024 -0700

      updated

commit aae754f46130b6d86680e74caa98642becc88d6e
Author: User Name <user@example.com>
Date:   Fri Oct 11 16:12:04 2024 -0700

      added
```

I want to do a partial reset to the earlier commit `aae75`. And I'm going to say "no" I don't want to reset the first hunk, and "yes" I want to reset the second. Here's what it looks like:

```
$ git reset -p aae75
diff --git b/foo.txt a/foo.txt
index 125f6ac..a982fdc 100644
--- b/foo.txt
+++ a/foo.txt
@@ -1,4 +1,3 @@
-Line BEGIN
  Line 1
  Line 2
  Line 3
(1/2) Apply this hunk to index [y,n,q,a,d,j,J,g/,e,p,]? n
@@ -7,4 +6,3 @@ Line 5
  Line 6
  Line 7
  Line 8
-Line END
(2/2) Apply this hunk to index [y,n,q,a,d,K,g/,e,p,]? y
```

The first question is asking, "Do you want to remove 'Line BEGIN'?" And I said "no". And the second question is asking "Do you want to remove 'Line END'?" And I said "yes".

Where are we?

```
$ git status
On branch main
Changes to be committed:
  (use "git restore --staged <file>..." to unstage)
    modified:   foo.txt

Changes not staged for commit:
  (use "git add <file>..." to update what will be committed)
  (use "git restore <file>..." to discard changes in working directory)
    modified:   foo.txt
```

Hmm. Let's check the difference between the stage and `HEAD`.

```
$ git diff --staged
diff --git a/foo.txt b/foo.txt
index 125f6ac..e0e1d89 100644
--- a/foo.txt
```

```
+++ b/foo.txt
@@ -7,4 +7,3 @@ Line 5
Line 6
Line 7
Line 8
-Line END
```

That's telling us that, compared to HEAD, the stage has the `Line END` removed. Which is great, because that's what we asked for with `reset -p`. So we're on track.

But why is `foo.txt` modified? Let's see:

```
$ git diff
diff --git a/foo.txt b/foo.txt
index e0e1d89..125f6ac 100644
--- a/foo.txt
+++ b/foo.txt
@@ -7,3 +7,4 @@ Line 5
Line 6
Line 7
Line 8
+Line END
```

This is telling us that, compared to the stage, the working tree has `Line END` added to the end.

And sure enough, if we look at the `foo.txt` file in the working tree, *it still has `Line END` in it.*

```
$ cat foo.txt
Line BEGIN
Line 1
Line 2
Line 3
Line 4
Line 5
Line 6
Line 7
Line 8
Line END
```

What does it all mean? Well, it means `reset -p` messed with the stage, but not with the working tree. Our working tree is still the same as it was with the last commit. (`git diff HEAD` will show no changes.)

Now, admittedly, it's likely this isn't what you want. Maybe you wanted to reset the hunk **and** get your working tree reset to that hunk, as well.

But we can still get there! Remember that the reset hunk is on the stage ready to be committed! Let's do that!

```
$ git commit -m "remove END"
[main 46badfe] remove END
1 file changed, 1 deletion(-)
```

There. Now the stage and HEAD are the same, both having had `Line END` removed. But `Line END` still exists in our working tree, like `status` informs us:

```
$ git status
On branch main
Changes not staged for commit:
  (use "git add <file>..." to update what will be committed)
  (use "git restore <file>..." to discard changes in working directory)
    modified:   foo.txt
```

So how do we get the reset change back into our working tree? The answer is right there in the hints.

```
$ git restore foo.txt
```

There. Now we're all on the same page with the `Line END` removed entirely.

There's another way to synchronize the stage and working tree during a patch reset. After you do the `reset -p`, you can copy the file `foo.txt` from the stage to the working tree with:

```
git checkout -- foo.txt
```

That will make the stage and working tree the same, so everything will all be on the same page when the commit is complete.

21.3 Other Patch Mode Commands

You can use `-p` with `stash`, `restore`, `commit`, and more. The UI behaves basically the same way as described above. See the manual pages for any particular command to learn more about it.

Chapter 22

Cherry-Pick: Bringing in Specific Commits

Let's say you're working on `branch1` and you have made a bug fix to `branch2`. You're not ready to merge *all* the changes in from `branch2` into `branch1`, but you really want just that bug fixed.

Luckily, there's a way to do that! You can merge a single commit into your branch with `git cherry-pick`. You just have to tell it which commit to bring in.

22.1 Cherry-Pick Example

Let's have a file on the `main` branch called `foo.txt` that has the following contents stored in an initial commit:

```
Line 1
Line 2
Line 3
Line 4
Line 5
Line 6
Line 7
Line 8
Line 9
Line 10
```

Very exciting file, that.

Now let's switch to another branch, call it `branch`, inspirationally.

And on this branch, we do some things. First, we add a couple lines to the end and commit.

```
Line 1
Line 2
Line 3
Line 4
Line 5
Line 6
Line 7
```

```
Line 8
Line 9
Line 10
Branch: Line 101
Branch: Line 102
```

And then we add a line to the middle, and commit again.

```
Line 1
Line 2
Line 3
Line 4
BRANCH: INSERTED LINE 5
Line 5
Line 6
Line 7
Line 8
Line 9
Line 10
Branch: Line 101
Branch: Line 102
```

Additionally let's create a branch here called `checkpoint` to make this demo a little easier. You don't *have* to do this, but it'll enable us to cherry-pick this commit by its branch name instead of by its commit hash. Or you could skip this step and just use the hash.

```
$ git branch checkpoint
```

This doesn't switch branches. It just makes a new branch on this commit. `HEAD` is still pointing to branch like before.

Lastly, let's add a couple more lines to the end, and commit one last time.

So here's the file as it exists on `branch`:

```
Line 1
Line 2
Line 3
Line 4
BRANCH: INSERTED LINE 5
Line 5
Line 6
Line 7
Line 8
Line 9
Line 10
Branch: Line 101
Branch: Line 102
Branch: Line 103
Branch: Line 104
```

And let's look at the log to see what we have:

```

commit 9336292f73b4ace717644336f72458681c1bb761 (HEAD -> branch)
Author: Branch User Name <branch-user@example.com>
Date: Sun Oct 20 13:08:30 2024 -0700

    branch: added line 103-104

commit 407f212f12f79902818431a174706cfdc30d509b (checkpoint)
Author: Branch User Name <branch-user@example.com>
Date: Sun Oct 20 13:08:30 2024 -0700

    branch: inserted line 5

commit 9533e0bdd5cba7d65401c3180b34b01700a7906e
Author: Branch User Name <branch-user@example.com>
Date: Sun Oct 20 13:08:30 2024 -0700

    branch: added line 101-102

commit d6953bd746c813f5ba545cf0fd6044fd78e2c617 (main)
Author: User Name <user@example.com>
Date: Sun Oct 20 13:08:30 2024 -0700

    added

```

Okay—that’s the set-up part of the demo. Now it’s time to cherry-pick!

What we’re going to want to do for the demo is switch back to `main` and then cherry-pick the one commit that inserts line 5 in the middle. You can always use its commit hash (`407f2`) for this, but we left behind that branch `checkpoint` there we can use instead.

Let’s do it.

```

$ git switch main
Switched to branch 'main'

$ git cherry-pick checkpoint
Auto-merging foo.txt
[main 9254663] branch: inserted line 5
Date: Sun Oct 20 13:08:30 2024 -0700
1 file changed, 1 insertion(+)

```

What that *should* have done is bring in that newly-inserted line 5, and none of the other changes. Let’s look at `foo.txt` from `main`:

```

Line 1
Line 2
Line 3
Line 4
BRANCH: INSERTED LINE 5
Line 5
Line 6
Line 7
Line 8

```

```
Line 9
Line 10
```

And there it is!

Wait—wasn't that just a merge? Not quite! Notice that we had added lines 101-102 in `branch` before we inserted line 5. And yet that earlier commit is not reflected in `main`. We *cherry-picked* that single commit with line 5 out of the stream of commits, ignoring the other ones before and after it!

Now let's look at `git log` on `main`:

```
commit 92546636d05fa85218ca18a0cd705ddc14fa8b64 (HEAD -> main)
Author: Branch User Name <branch-user@example.com>
Date:   Sun Oct 20 13:08:30 2024 -0700

    branch: inserted line 5

commit d6953bd746c813f5ba545cf0fd6044fd78e2c617
Author: User Name <user@example.com>
Date:   Sun Oct 20 13:08:30 2024 -0700

    added
```

There are two amazing things to notice here:

1. The author information was preserved in the log message. Notice it's `branch-user@example.com` and not `user@example.com`, even though it was the latter who did the cherry-pick. This might not be entirely surprising, except...
2. The cherry-picked commit hash is different in `main` than in `branch`! In `branch`, it's `407f2`, and here it's `92546`. But it **has** to be that way because it's got all new content. That is, there's no other commit anywhere in the commit graph where `foo.txt` looks like this, so it has to have a unique commit hash¹.

But not every cherry-pick will go as smoothly as that!

22.2 Cherry-Pick Conflicts

Yes, you can get conflicts with a cherry-pick, of course. This might happen because you've changed some of the same lines as the commit you're cherry-picking, or maybe because the cherry-picked commit has some contextual lines of code that you don't have.

In any case, conflict resolution happens in the much the same way as with `merge` or `rebase`. If you need to, refamiliarize yourself with the content from those chapters.

But by now I hope the process seems familiar. First, make the file *Right*, then add it, and then you'll *continue* (like with a `rebase`) with `git cherry-pick --continue`. Keep doing that until everything's merged together cleanly.

¹Even if the changes were identical, the commit hash would still be different because the hash takes all kinds of other metadata into account.

Chapter 23

Who's to Blame for this Code?

Let's say you find something in the shared codebase that's just wrong. Or, charitably, we'll say you found something *interesting*.

And you want to know who was to blame for that *incredible* code.

This is where a simple Git command can enlighten you.

Here's some example truncated output (so that it fits in the book margins):

```
$ git blame --date=short foo.py
8c96991f (Alice 2024-10-08 4) def encode_data(message, value):
8c96991f (Alice 2024-10-08 5)     encoded_message = message.encode()
8c96991f (Alice 2024-10-08 6)     encoded_value = value.to_bytes(
3b0b0e76 (Chris 2024-10-09 7)         length = len(encoded_message)
3b0b0e76 (Chris 2024-10-09 8)         encoded_length = length.to_bytes(
8c96991f (Alice 2024-10-08 9)
8c96991f (Alice 2024-10-08 10)        data = encoded_length + encoded_value
8c96991f (Alice 2024-10-08 11)
8c96991f (Alice 2024-10-08 12)        return data
```

I have the `--date=short` switch in there to compress it even more so it fits in the book. Otherwise it would show a full time stamp.

What we see in this fabricated example is that Alice has checked in the majority of this function, but the next day Chris came in and modified or added those additional lines in the middle.

And now we know.

23.1 Fancier Blaming

You can use the `--color-lines` switch to get color output, alternating colors between commits. Very exciting. If you want that to always happen, you can set the `color.blame.repeatedLines` config option.

We already saw `--date=short` to chop the date down a bit.

You can show the email address of the contributor with `-e` or `--show-email`.

You can reliably detect lines that were moved or copied within a file with `-M`. And you can do the same thing across multiple files with `-C`.

Finally, your IDE (like VS Code) might support blame, either natively or via an extension. Some people just have this feature turned on all the time.

Chapter 24

Configuration

Waaaaay back at the beginning of this book, we did some Git configuration. We did this:

```
$ git config set --global user.name "Your Name"
$ git config set --global user.email "your-email@example.com"
```

When we did, it added that configuration information to a file and the info in that file applies to all the Git repos on your system.

Unless you override them with a local config, that is. But stay tuned for more on that later.

Some of you might be saying, “Hey, I’ve never written `set` before to set variables with `git config`!” And you’d be right. But that’s the old, deprecated way of using `git config`. If you’re using an older version of Git, the deprecated way might be the only way. So if you’re getting errors with the new usage, see Older Git Versions, below.

Let’s look at one of those lines again:

```
$ git config set --global user.name "Your Name"
                        ↑           ↑
                    variable   value
```

There are two main things in this line.

1. A *variable*, that is, the thing we’re setting the value of.
2. A *value*, the value we’re giving that variable.

In that case, the variable is `user.name` and the value is `"Your Name"`.

What those two variables, `user.name` and `user.email`, are doing is they’re setting the values that will go in your commit messages! That’s your identity when you commit! A side note here it that it’s incredibly easy to impersonate anyone else in the world just by putting their name and email there. To mitigate this, one option is to digitally sign your commits^a, something you can read a little bit more about in the Changing Identity chapter.

^a<https://git-scm.com/book/en/v2/Git-Tools-Signing-Your-Work>

If the commands in this chapter are giving you errors, see the section on older Git versions, below.

24.1 Local Configuration

In those `git config` lines, above, you might have noticed the `--global` switch:

```
$ git config set --global user.name "Your Name"
```

Unless you explicitly say `--global`, Git assumes you mean the local configuration.

What is the local configuration? It's the configuration that applies to the repo that you're currently in, and no others.

Configuration options in the local config override the global config!

Here's a practical example of why you might do this. Let's say you have a personal email for your fun projects, and a contractor email that you use for work-for-hire. But since you're an independent contractor, you have all these projects on one computer.

However, you want to use your work identity (name and email) for your contract work and your hacker identity for your fun work.

One thing you might do is set the following globally:

```
$ git config set --global user.name "HAX0rBYnit3"
$ git config set --global user.email "l333T@example.com"
```

and that would be the default for all your repos. And then you might have a new repo for a job:

```
$ git init corporate_job_12
Initialized empty Git repository in /user/corporate_job_12/.git/
```

And we pop in there, and we set the local config just for that repo (it's local because we're not specifying `--global`):

```
$ cd corporate_job_12
$ git config set user.name "Professional Name"
$ git config set user.email "professional@example.com"
```

And now, just in the `corporate_job_12` directory, we'll be using our professional name and email in our commits. Everywhere else we'll be using our elite hacker name.

You can override all the global configs on a per-repo basis by specifying local configs.

Finally, the local config for a repo is found in the `.git/config` file out of the repo's root directory.

24.2 Listing the Current Config

You can view the current config with `git config list`. Add the `--global` flag if you want to see the global config.

```
$ git config list
user.name=HAX0rBYnit3
user.email=l333T@example.com
init.defaultbranch=main
core.repositoryformatversion=0
core.filemode=true
```

```
core.bare=false
core.logallrefupdates=true
user.name=Professional Name
user.email=professional@example.com
```

You can see in there that `user.name` and `user.email` appear twice. The first is from the global config, which is overridden later by the value in the local config.

24.3 Getting, Setting, and Deleting Variables

An example “get”:

```
$ git config get user.name
Professional Name
```

Note that it is only giving the active value (the local one in this case) even though we saw with `git config list` that both the global and local values were there.

And we’ve already seen a “set”:

```
$ git config set user.name "Alfred Manfregensenton"
```

The double quotes are there so that the shell delivers the name as a single argument. Normally it splits all arguments on spaces. You could also use single quotes which is useful if the value has special shell characters in it. The grotesquely oversimplified rule, with apologies to shell enthusiasts, is to use quotes around the value if it has a space in it.

Set will overwrite any previously-existing value of the name variable name.

And last but not least, we can delete a variable with `unset`:

```
$ git config unset user.name
```

24.4 Some Popular Variables

To see which variables you can set, look in the manual page for the appropriate command. You can usually get there by looking at the first hit on your favorite search engine for `man git whatever`. For example, you might find configuration variables for `git pull` by searching for `man git pull` and bringing up the first hit.

That said, there’s a big ol’ list of them in the `git config` manual page that you can peruse¹.

But here are some fun, common ones.

Variable	Description
<code>user.name</code>	Your name
<code>user.email</code>	Your email
<code>pull.rebase</code>	Set to <code>true</code> to have a pull try to rebase. Set to <code>false</code> to have it try to merge.
<code>core.editor</code>	Your default editor for commit messages, etc. Set to <code>vim</code> , <code>nano</code> , <code>code</code> , <code>emacs</code> , or <code>whatever</code> .
<code>merge.tool</code>	Your default merge tool, e.g. <code>meld</code> or <code>whatever</code> .
<code>diff.tool</code>	Your default diff tool, e.g. <code>vimdiff</code>

¹https://git-scm.com/docs/git-config#_variables

Variable	Description
<code>difftool.prompt</code>	Set to <code>false</code> to stop Git from always asking you if you want to launch your <code>difftool</code> .
<code>color.ui</code>	Set to <code>true</code> for more colorful Git output
<code>core.autocrlf</code>	Set to <code>true</code> if you're on Windows and not in WSL and the remote repo has Unix-style newlines and you want to use Windows-style newlines in your working directory. On other systems, set to <code>input</code> . This is all about working around Windows' ancient newlines.
<code>commit.gpgsign</code>	Set to <code>true</code> if you've configured GPG commit signing and want to always sign.
<code>help.autocorrect</code>	Set to <code>0</code> to show the command Git thinks you meant to type if you misspelled it. Set to <code>immediate</code> to have it run the corrected command right now. Set to <code>prompt</code> to ask you if you want to run it.

Again, there are a *lot* more of these. Peruse the docs for more.

24.5 Editing the Config Directly

You can launch an editor (the one specified in the `core.editor` variable) to edit the config file directly. Some people might find this easier.

I can launch the editor like this:

```
$ git config edit
```

Add the `--global` flag to edit the global config file.

When you get into the editor, you'll see a config file that might look something like this:

```
1 [core]
2   repositoryformatversion = 0
3   filemode = true
4   bare = false
5   logallrefupdates = true
6
7 [user]
8   name = Your Name
9   email = user@example.com
```

If you look, you can see where `user.name` and `user.email` ended up. That's how the config file is organized.

So you can edit it here and save those changes. Some people might find this easier than adding or modifying variables on the command line.

If you corrupt your config with sloppy editing, you're in for an interesting time. You won't be able to run `git config edit` again. You'll have to manually fix the config file in your favorite text editor.

The local config file can be found relative to the root directory for the repo in question in `.git/config`.

The global config file can be found at `~/.gitconfig` on Unix-like systems and `C:\Users\YourName\.gitconfig` on Windows.

Bring the appropriate file up in your editor, fix the mistake, save it, and then `git config edit` should work again.

24.6 Conditional Configuration

This is more than I want to talk about, but it's neat enough to point out.

In Git config files, you can *include* other config files. This gives you a way, if your config files are bananas, to break them apart logically.

You can also do *conditional includes*. That is, you can choose to include a file based on some condition being true.

Testable conditions are:

- Which directory this repo is in
- If you're on a particular branch
- If there is a particular remote configured

This gives you all kinds of power. Personally, all of it is more than I need, and I've never used this feature, but that's just me.

Get more info and examples in the official book².

24.7 Older Git Versions

I'm assuming you have a recent version of Git installed. But if you don't, these commands might be different.

The Git manual page for `git config` has a complete summary of the changes³.

And here are the modern commands we used in this chapter:

```
git config get user.email           # Get
git config set user.email "user@example.com" # Set
git config unset user.email         # Delete
git config list                     # List
git config edit                     # Edit
```

And here are the older equivalents:

```
git config user.email               # Get
git config user.email "user@example.com" # Set
git config --unset user.email       # Delete
git config --list                   # List
git config --edit                   # Edit
```

Use the new ones if you can!

²https://git-scm.com/docs/git-config#_conditional_includes

³https://git-scm.com/docs/git-config#_deprecated_modes

Chapter 25

Git Aliases

Some of these Git commands might be painstaking to type. So far, we haven't had to do anything *too* complicated, but we might eventually.

For example, let's say you want to see the names of the files that were modified with `git log`. It's no problem; you can tell it to do that.

```
$ git log --name-only
```

And that'll work.

But let's say for the sake of example that you find yourself doing that a *lot*. It would get irksome.

Wouldn't it be easier if you could just make up a new command, like `git logn` that would do the same thing?

That's what aliases are for.

This chapter assumes you've read the Configuration chapter. In particular, if these commands don't work, you should look at configuration of Older Git Versions.

25.1 Creating an Alias

You do this through the configuration interface. Basically what you want to set is the variable `alias.myname` where `myname` is the name of the new command.

Let's say you want to make `git logn` an alias for `git log --name-only`. You can do it like this:

```
$ git config set --global alias.logn 'log --name-only'
```

And at this point, you can run:

```
$ git logn
```

and it will be an alias for `git log --name-only`, effectively running that command.

I speculate that Git has a number of built-in commands (like `log` and `push`) and if you try to have it run something that is not a built-in, it tries to find it as an `alias` variable. And if it does, it substitutes that instead. 99% sure that's what's happening under the hood.

Since aliases are just regular configuration variables, getting, setting, and deleting them happens as described in the config chapter.

25.2 Displaying Aliases

Since aliases are just config variables, you can just get them in order to see what they are.

```
$ git config get alias.logx
```

If you want to see all of them, you can run this command:

```
$ git config get --all --show-names --regexp '^alias\.'
```

which is super annoying. I suggest you alias it. Wheee!

Older versions of Git use this command instead:

```
$ git config --get-regexp ^alias\.
```

25.3 Some Neat Sample Aliases

Some of the following are split into multiple lines so they fit in the book. You can put them on a single line, or type them as-is with the `\` escape that tells the shell to continue the command on the next line.

Add all changed files with `git adda`. Do this carefully since you might add more than you wanted!

```
$ git config set alias.adda "add --all"
```

More compact log showing the commit graph with `git logc`.

```
$ git config set alias.logc "log --oneline --graph --decorate"
```

Diff the stage with the repo with `git diffs`.

```
$ git config set alias.diffs "diff --staged"
```

Make git aliases show all aliases with `git aliases`.

```
$ git config set alias.aliases \  
"config get --all --show-names --regexp '^alias\.'"
```

Make a very colorful and customized log with `git lol`.

(Make sure to get the spacing exactly as-is on this copy-paste or the shell and/or Git will be unhappy.)

```
$ git config set alias.lol "log --graph\  
" --pretty=format:'%Cred%h%Creset -%C(yellow)%d%Creset %s\  
" %Cgreen(%cr) %C(bold blue)<%an>%Creset' --abbrev-commit"
```

For that last one, we're making heavy use of `--pretty` formatting which gives tons of control over the output. See the "Pretty Formats" section of the `git log` manual page for more info¹.

¹https://git-scm.com/docs/git-log#_pretty_formats

25.4 Seeing Git's Alias Expansion

Let's say you've added an alias, but it's not working. When you run it, it just gives some error and it's not super clear what's going on.

```
$ git logx
fatal: unrecognized argument: --foobar
```

You can ask Git to give you more information by adding `GIT_TRACE=1` to the beginning of the command line.

This sets the environment variable `GIT_TRACE` to 1, but it only does it for this one command. It's not persistent. Git knows to look for `GIT_TRACE` and that it should alter its behavior if it finds it.

Here's some example output:

```
$ GIT_TRACE=1 git logx
14:09:28.502707 git.c:758          trace: exec: git-logx
14:09:28.502750 run-command.c:666  trace: run_command: git-l
14:09:28.502905 git.c:416          trace: alias expansion: l
14:09:28.502913 git.c:816          trace: exec: git log --fo
14:09:28.502916 run-command.c:666  trace: run_command: git l
14:09:28.502926 run-command.c:758  trace: start_command: /us
14:09:28.504192 git.c:472          trace: built-in: git log
fatal: unrecognized argument: --foobar
```

Unfortunately I had to truncate the lines on the right so they fit in the print version of the book, and that's what we really want to look at. We'll get there in a moment.

For now, let's look on the left. What we see there is a timestamp and some information about which part of the Git code is sending the trace out. And the it ends with our error.

Let's scroll to the right and just look at the lines following the `trace:`.

```
trace: exec: git-logx
trace: run_command: git-logx
trace: alias expansion: logx => log --foobar
trace: exec: git log --foobar
trace: run_command: git log --foobar
trace: start_command: /usr/lib/git-core/git log --foobar
trace: built-in: git log --foobar
```

It might take some sifting through, but let's look just at the lines with `run_command` and `alias expansion` in them:

```
trace: run_command: git-logx
trace: alias expansion: logx => log --foobar
trace: run_command: git log --foobar
```

And there we can see exactly what's being expanded into what. And that might be useful for debugging it.

It's probably a bit of overkill for this simple example, but there are some aliases of extraordinary complexity for which this technique might help.

Chapter 26

Changing Identity

There are a few ways you're identified when you do work with Git.

They are held in:

- the `user.name` and `user.email` configuration variables
- the SSH key you use to authenticate with a remote server like GitHub
- the GPG key you use for signing commits (rare)

It's all well-and-good if you only ever use a single identity, but sometimes you might want to use different ones. For example, maybe for your personal fun work, you use one identity and SSH key, but then you got a contract job and you want to use your professional email and have to connect to a different server with a different SSH key.

Let's check out what the defaults are for all these, as well as how to change them on a per repo basis.

26.1 Changing the User Configuration Variables

You'll want to do this if you have, say, some repos for work and some for play, or if you have multiple work or play emails you want to use on a per-repo basis.

Everyone, including me, will tell you that you shouldn't use your work-assigned laptop for play, and you double-especially shouldn't do that if your "play" is other work-for-hire. That said, contractors often have multiple things going on at once (and they own their hardware), and sometimes people doing their own for-fun work might want to use different emails on different projects.

We've already covered this in the configuration chapter, but it's easy enough to change your local identity that's attached to each commit. Just change `user.name` and `user.email` to whatever you want.

In the repo in question, set the local configuration to override your global config:

```
$ git config set user.name "My Alter Ego User Name"
$ git config set user.email "alterego@example.com"
```

And then when you make commits in this repo, that's the identity that will be attached to them. Commits in other repos will still obey your global username and email (unless you've overridden them, as well).

26.2 Changing the SSH Authentication Key

You'll want to do this if you're connecting to someone's private remote (e.g. they're running a Gitea site of their own or something), and you need to set up a different SSH key just to access that site. But you want to keep using your same SSH key for your personal GitHub. How can we use the GitHub one for all my repos, and the alternate SSH key just for this one repo?

This is slightly more involved, and there are a few ways to do this¹, but I'll share my favorite here.

First some background. When the `ssh` command runs, it needs to know which identity it is running as. It uses a default identity (which is in a file called `~/.ssh/id_something`, like `id_ed25519`) unless you specify another one.

You can do this one the command line with the `-i` switch to `ssh`.

Let's say you have two private keys in your `.ssh` directory, `id_ed25519` and `id_alterego_ed25519`. The first one is the default key SSH uses. But if we want to use the other one, we can specify it:

```
$ ssh -i ~/.ssh/id_alterego_ed25519 example.com
```

Admittedly, that's a pain in the butt to type, so some people set up their SSH config to use a particular key with a particular host name. But we're not going down that route.

Instead, let's tell Git to use a particular identity by setting the `core.sshCommand` variable locally for this repo. This variable just holds the SSH command that Git uses to connect, which would normally be `ssh`. Let's override:

```
$ git config set core.sshCommand \  
"ssh -i ~/.ssh/id_alterego_ed25519 -F none"
```

(The command above is split into two lines to fit in the margins—it is normally a single line and the `\` is Bash's line continuation.)

And—wait a second—what's that `-F none` on there? That's just a safety that's telling SSH to ignore its default configuration file. Remember how above I said people sometimes set an identity by domain in their SSH config? This would override that since overriding is what we're trying to do here.

The reason I like this approach is that you can easily do it on a per-repo basis, and the config is stored with the repo (instead of in an environment variable or in SSH's somewhat-unrelated configuration).

26.3 Changing your GPG Signing Key

If you use your GPG key² for signing you can specify which key is used if you get its fingerprint (or probably email or any other unique identifier recognized by GPG).

With apologies, setting up your GPG keypair is outside the scope of this book. But the Git-side one-time setup looks like this:

```
$ git config gpg.format gpg  
$ git config commit.gpgsign true
```

First find the secret key you're interested in:

¹<https://superuser.com/questions/232373/how-to-tell-git-which-private-key-to-use>

²<https://www.gnupg.org/>

```
$ gpg --list-secret-keys --keyid-format LONG
/user/.gnupg/pubring.kbx
-----
sec  rsa4096/0123456789ABCDEF 2022-01-01 [SC] [expires: 2025-01-
9993456789ABCDEF0123456789ABCDEF01234567
uid  [ultimate] Personal User Name <personal@example.com>
ssb  rsa4096/9993456789ABCDEF 2022-01-01 [E] [expires: 2025-01-0
sec  ed25519/ABCDEF0123456789 2022-01-01 [SC] [expires: 2025-01-
FFFDEF0123456789ABCDEF0123456789ABCDEF01
uid  [ultimate] Professional User Name <professional@example.c
ssb  rsa4096/FFFDEF0123456789 2022-12-06 [E] [expires: 2024-12-0
```

(Output has been cropped on the right to fit in the book.)

Look for the identity you want to use. In this case, let's say we want to use "Professional User Name". We look for the `sec` line that's associated with it (above it), and we copy that part of the secret line after the type of encryption (usually `rsa4096` or `ed25519`). Here that's `ABCDEF0123456789` in this fabricated example.

And then we locally configure this repo to use that key in particular.

```
git config set user.signingkey ABCDEF0123456789
```

Then when you sign the commits, that key will be used.

26.4 Changing your SSH Signing Key

In addition to GPG, you can also sign commits with SSH keys. You can create a signing key with `ssh-keygen`:

```
$ ssh-keygen -t ed25519
```

And then you have to do some one-time config if you haven't done so already. Use `--global` if you want to set this up across all your repos. This tells Git to use SSH keys and always sign commits:

```
$ git config gpg.format ssh
$ git config commit.gpgsign true
```

Then we can set the key we use for signing. Change the path, below, to point to the public key:

```
$ git config user.signingkey ~/.ssh/id_ed25519_signing.pub
```

Lastly, we have to add your information to the `allowed_signers` file. This file can go anywhere; in this example, we'll put it in `~/.ssh/`, but you could do one-offs per repo if you wanted.

Firstly in this lastly step is to tell Git where your `allowed_signers` file is.

```
$ git config gpg.ssh.allowedSignersFile "~/.ssh/allowed_signers"
```

The contents of that file should have at least two fields. First the email address found in your `user.email` config variable that you'll use for the commits. Second, a copy of the public key from your `user.signingkey` variable. Note that you want the *contents* of that file, not the file name.

An example line in the `allowed_signers` file looks like this (line truncated for formatting):

```
user@example.com ssh-ed25519 AAAAC3NzaC1lZDI1NTE5AAAAIAmaTS47vRmsKy
```

You can have multiple lines in that file for multiple identities.

Chapter 27

Amending Commits

Git gives you the power to relatively easily amend the last commit.

Caution! This section talks about changing history, and let's not forget The One Rule Of Changing History: thou shalt not change history of anything that you've pushed, lest someone else might have already pulled thy earlier changes, causing your commit histories to become woefully out of sync and much shouting.

In short, if you pushed a change, assume someone else has pulled it already and amending your commit (changing history) would cause lots of pain.

In shorter, if you pushed, it's too late. No more amending the commit.

So what are some use cases?

- Maybe you botched the commit message and you want to rewrite it.
- Maybe you forgot to add some files.

That kind of thing that none of us have ever done ever, right?

27.1 Amending the Commit Message

This one is pretty easy. Let's take an example of a commit that I've botched. Note that this is completely committed at this point—I've already run `git commit`. But, crucially, I haven't pushed yet.

Let's get a status and see the log:

```
$ git status
On branch main
nothing to commit, working tree clean
$ git log
commit d7fba6838a689c3de15a27e272e8e4123d7c2460 (HEAD -> main)
Author: User <user@example.com>
Date: Thu Nov 21 20:39:04 2024 -0800

    added
```

That's one "d" too many in the commit message. Fixing it up is as easy as this:

```
$ git commit --amend
```

And that brings me right into my editor where I can change the message.

If I don't want to use the editor, I can do it on the command line:

```
$ git commit --amend -m "the new commit message"
```

Note that doing this preserves the author of the commit. (Which is probably what you want 99.9999% of the time since you were probably already the author.) If you want to change the identity, you'll have to reconfigure your identity with `git config` and then run:

```
$ git commit --amend --reset-author
```

27.2 Adding some Files to the Commit

Ugh! You just made that commit but you forgot to add one of the files to it! You got `foo.c` and `bar.c` in there, but you left out `baz.h`!

Let's look.

```
$ ls
bar.c baz.h foo.c
$ git log --name-only
commit b307686933dca3db718e6a3e3f8226be11e7e278 (HEAD -> main)
Author: User <user@example.com>
Date: Thu Nov 21 20:47:08 2024 -0800

    added

bar.c
foo.c
```

OK, so how can we get `baz.h` in there? Like this:

1. `git add baz.h` to add it to the stage.
2. `git commit --amend` to get it into the commit.

This will bring you into an editor to edit the commit message. You can just save it as is. Or you can specify the `-m` option on the command line to give a new message.

Alternately, if you're just adding files, you might not need to change the commit message at all. In that case you can just run:

```
$ git commit --amend --no-edit
```

That'll run the amend and not edit the commit message at all.

And there we have it—you can easily amend the last commit. Just be sure you haven't pushed it before you do.

This might be a little tough to see in black and white, but what we have is the old version on the left and the new version on the right. The lines of minus signs on the left indicate lines that don't exist in the old version, and we can see highlighted lines on the right that exist in the new version.

But if you just try to run `git difftool` out of the box, it won't work. You have to configure it first.

28.1 Configuring

Firstly, Git normally prompts you before launching a third-party difftool. This is annoying, so let's turn it off globally:

```
$ git config --global difftool.prompt false
```

Secondly, we need to tell it which tool to use.

```
$ git config --global diff.tool vimdiff
```

And that might be enough. If `vimdiff` (or whichever diff tool you're using) is in your `PATH`¹, you should be in business and you're good to go.

If it's not in your `PATH`, maybe because you installed it locally in your home directory tree somewhere, you can either add it to your `PATH` (search the Net for how to do this), or you can specify the full path to your particular difftool. Here's an example with `vimdiff`, which is redundant for me because `/usr/bin` is already in my `PATH`.

```
$ git config --global difftool.vimdiff.path /usr/bin/vimdiff
```

If you're using a different difftool other than `vimdiff`, replace that part of the config line with the name of the command.

Again, you only have to set the path if the tool isn't installed in a standard place.

28.2 Available Difftools

There are a number of diff tools out there you can choose from. Here's a partial list, with the caveat that I've only ever used Vimdiff.

- Araxis Merge²
- Beyond Compare³
- DiffMerge⁴
- Kdiff3⁵
- Kompare⁶
- Meld⁷
- P4Merge⁸

¹Setting the `PATH` is outside the scope of this tutorial, but the short of it is if you can run the diff tool command on the command line (e.g. by running `vimdiff`), then it is in the `PATH`. If it says `command not found` or some such, then it is **not** in the `PATH`. Search the Intertubes for how to add something to the `PATH` in Bash. Or set the Git path config explicitly, as shown in the following paragraph.

²<https://www.araxis.com/merge/index.en>

³<https://www.scootersoftware.com/>

⁴<https://sourcegear.com/diffmerge/>

⁵<https://kdiff3.sourceforge.net/>

⁶<https://apps.kde.org/kompare/>

⁷<https://meldmerge.org/>

⁸<https://www.perforce.com/products/helix-core-apps/merge-diff-tool-p4merge>

- Vimdiff (comes with Vim⁹)
- WinMerge¹⁰

Some of these are free, some are paid, and some are free trial.

And remember, VS Code has this functionality without using difftool.

⁹<https://www.vim.org/>

¹⁰<https://winmerge.org/?lang=en>

Chapter 29

Mergetool

Do you hate all those >>>>, =====, and <<<<< things that Git puts in your files during a merge conflict?

If so, using a *merge tool* might be what you're after. A merge tool will give you a graphical display showing your changes, the conflicting changes, and the desired result of the merge. And it shows it in an easy-to-digest form.

Personally, I dislike merge tools. That seems nuts, but let me explain a moment. When you're in a merge conflict, the only thing you have to do is edit those files with the ===== delimiters and make them *Right*, remember? You have to modify the file until it is correct, ripping out those delimiters as you go.

It's just you and the file, that's it. No intermediaries messing with the contents. And when you're done, what you have is your final answer.

But merge tools are intermediaries by their very nature. And we must trust that we're using them correctly to get the job done. And, for me, even after I've used them probably correctly, I still feel like I have to manually inspect the result to make sure it's *Right*.

The benefit I do see is that with a merge tool you typically get a side-by-side view of the changes, as opposed to the up-and-down view you effectively get when editing the conflicting file. This can make the merge tool easier to use when you have a number of big conflicting hunks in a file.

But in real life, I never use one. Also in real life, *lots* of people use them.

29.1 Merge Tool Operations

Merge tools operate on a file-by-file basis. So when you're using one, you're using it on a particular conflicting file.

They all tend to show you at least three panels:

- Your conflicting changes
- Their conflicting changes
- The result file that is *Right*

And they all tend to have the same core operations:

- **Go to next conflict**—all panels will move to the next conflict.
- **Go to previous conflict**
- **Choose yours**—copy *your* conflicting changes into the final result, i.e. your changes are *Right*.
- **Choose theirs**—copy *their* conflicting changes into the final result, i.e. your changes are *Right*.

In terms of usage, here's what we're going to do, assuming that the merge tool starts you at the first conflict when it is launched:

1. Choose either “yours” or “theirs” to keep the *Right* changes.
2. Go to the next conflict.
3. Repeat from Step 1 until all conflicts are resolved.

After you've gone through all the conflicts and chosen one or the other, make sure the final result is *Right* and then save/finish the result.

The merge tool will have staged the result for you, ready to commit and finish the merge.

29.2 Some Example Merge Tools

There are a lot of them, and I'll include some links here in alphabetical order. Cross-platform unless otherwise noted.

- Araxis Merge¹—Windows, Mac
- Beyond Compare²
- Code Compare³—Windows
- KDiff3⁴
- Meld⁵
- P4Merge⁶
- Vimdiff⁷
- WinMerge⁸—Windows

In addition, IDEs like VS Code and IntelliJ often have their own built-in merge tools that work independent of Git (no need to configure anything in Git).

29.3 Using Vimdiff as a Merge Tool

We'll do a quick run-through of using Vimdiff as a merge tool since it covers all the bases and has some tricky configuration. Other third-party tools (except VS Code and other IDEs with this functionality built-in) would have a similar configuration. Search the Internet for the proper config for other tools.

This isn't a Vim tutorial. So I'm just going to assume you know how to do things like save files and quit. I will say that to switch windows in Vim you use `CTRL-W` followed by a cursor direction, such as `CTRL-W` followed by `h` to move to the window to the left.

First things first, let's set up the configuration.

```
$ git config --global set merge.tool vimdiff
$ git config --global set mergetool.vimdiff.cmd \
    'vimdiff "$LOCAL" "$REMOTE" "$MERGED"'
$ git config --global set difftool.vimdiff.cmd \
    'vimdiff "$LOCAL" "$REMOTE"
```

(Long commands split to fit in the book margins—it could be on a single line.)

¹<https://www.araxis.com/merge/index.en>

²<https://www.scootersoftware.com/>

³<https://www.devart.com/codecompare/>

⁴<https://invent.kde.org/sdk/kdiff3>

⁵<https://meldmerge.org/>

⁶<https://www.perforce.com/products/helix-core-apps/merge-diff-tool-p4merge>

⁷<https://www.vim.org/>

⁸<https://winmerge.org/>

Note that last line is to explicitly set a two-panel view for `vimdiff` and `difftool`. If it's not set, the `mergetool.vimdiff.cmd` directive will make `difftool` have a three-panel display—probably not what you wanted.

Once that's in place, let's say we have a merge conflict.

```
$ git merge branch
Auto-merging foo.txt
CONFLICT (content): Merge conflict in foo.txt
Automatic merge failed; fix conflicts and then commit the result.
```

At this point, we're in a classic run-of-the-mill merge conflict.

```
$ git status
On branch main
You have unmerged paths.
  (fix conflicts and run "git commit")
  (use "git merge --abort" to abort the merge)

Unmerged paths:
  (use "git add <file>..." to mark resolution)
   both modified:   foo.txt

no changes added to commit (use "git add" and/or "git commit -a")
```

But since we've set up our merge tool, let's use it:

```
$ git mergetool
```

If Git is prompting you to ask if you really want to run the merge tool (which you presumably do since you just ran `git mergetool`), you can turn off that “feature” with this config command:

```
$ git config --global set mergetool.prompt false
```

This is going to bring up a Vim window with three panels. The left is your local changes, the middle is the file as it exists in the repo, and the right is the result of the merge.

The goal is to make the one on the right look *Right*. Now, you could just do that outright by modifying the file there, but at that point, why even use a merge tool?

So we'll follow the steps we outlined earlier.

When we first run `git mergetool`, we get dropped at the first conflict with the cursor in the left window. The left window holds the changes we made.

In the middle window, we'll see the corresponding changes that are in the repo.

And in the right repo, we see what will be staged when we're done. Right now in the right window, we see all the `=====` and `<<<<<` stuff. But we'll change that in a moment.

Move the cursor to the right window. This is where the action will be.

Make sure the cursor is on a highlighted section (which probably will be in multiple colors). This highlighted section is what we'll replace.

Let's choose which change to use.

If you want to keep your changes (and ditch the ones in the repo), use this Vim command:

```
:diffget LOCAL
```

If you want to discard your changes (and keep the ones in the repo), use this command:

```
:diffget REMOTE
```

When you run one of those, you'll see the content in the right window change to what you wanted.

And then you can go to the next conflict with `]c`. (or to the previous with `[c`.)

Do this until the right window is *Right*. Note that you are also free to edit the right window directly all you want.

When you're done, save the right window and quit all the windows.

Importantly the second you exit the merge tool, Git will stage whatever you saved in the rightmost window. If you exited too soon and got stuff staged before you were done, use `git checkout --merge` with the file in question to get it off the stage and back to “both modified” state.

If there are multiple conflicting files, Git will bring up the merge tool again to handle the next file in line.

And when you're done, the changes are made and you can finish the merge with a commit as per usual.

But wait—what's that `.orig` file that wasn't there before? Read on!

29.4 Backing up the Originals

By default, when using a merge tool, Git will keep a backup of the file before the merge tool touched it. You'll see these with a `.orig` extension, like so:

```
foo.txt.orig  
bar.txt.orig
```

You can add these to your `.gitignore` if you want to, or you can prevent the creation of them in the first place with this configuration variable:

```
$ git config --global set mergetool.keepBackup false
```

Chapter 30

Submodules

You can't really have a Git repo *inside* a Git repo. I mean, yes, you can make one, but when you try to add it to the outer repo, Git will have a lot to say about it.

```
warning: adding embedded git repository: inner
hint: You've added another git repository inside your current
hint: repository. Clones of the outer repository will not contain
hint: the contents of the embedded repository and will not know how
hint: to obtain it. If you meant to add a submodule, use:
hint:
hint:     git submodule add <url> inner
hint:
hint: If you added this path by mistake, you can remove it from the
hint: index with:
hint:
hint:     git rm --cached inner
hint:
hint: See "git help submodule" for more information.
hint: Disable this message with "git config advice.addEmbeddedRepo
hint: false"
```

So it's probably not what you want, but Git offers a hint: maybe you wanted something to do with submodules, instead!

Submodules give you a way to make a completely separate repo appear inside the working tree of your current repo. Not only that, it allows the current working tree to have a specific commit of the submodule represented in that submodule's tree.

The canonical use case for this is when your project depends on a library that you also have the source for. You can include the library's repo as a submodule of your repo, and effectively pin it to a particular version (specifically to a particular commit).

For example, maybe your code works with FooLib version 3.4.90. So you include FooLib as a submodule and make sure it's pinned to that version. Then even though another team might be updating FooLib, you'll always have version 3.4.90 available to build against.

Then later when you're ready, you can update the submodule to the latest version, say 4.0.1, and pin that one in place.

It's important to note that a submodule is just another regular Git repo. Nothing special about it. The only thing that's notable is that we've decided to effectively clone it inside another repo, and logically tie it to that

repo.

30.1 Using a Repo with Submodules

Let's start by talking about what happens when you clone a repo that already uses submodules. In this case, someone else has done the work of putting the repo together with its submodules, but you have to do a little bit of extra effort after cloning it so you get all the submodules, as well.

Later we'll talk about how to add submodules to a project.

Luckily, for demonstration purposes, I have a repo you can clone that already has a submodule defined within it. (Fork the repo before you clone it if you want to be able to push back.)

Let's say you already know that the repo you're about to clone has submodules. (Because someone told you it did.) You can then clone with a flag saying you want to get all the submodule repos, too, please. You do this with the `--recurse-submodules` switch:

```
$ git clone --recurse-submodules \  
    git@github.com:beejjorgensen/git-example-submodule-repo.git
```

(Above command split into two lines to fit in the margins.)

And that will clone the repo in question, and it will also clone all repos listed as submodules of that repo. Go ahead and run it—it's a real repo you can clone.

After you run it and go into the repo directory, you'll see a `git-example-repo` directory in there. That's a completely separate repo inside this one as a submodule. You can `cd` into it and look at the files!

Any Git commands you run in the submodule directory tree apply only to the submodule! Be extra careful making commits in the submodule directory tree—`HEAD` commonly gets detached with submodules. More on that later.

But let's say you forget to specify `--recurse-submodules`, or you just plain didn't realize there were submodules here. Not to worry! You can get them after the fact. The above command is the same as these two (or three) commands:

```
$ git clone \  
    git@github.com:beejjorgensen/git-example-submodule-repo.git  
$ cd git-example-submodule-repo  
$ git submodule update --recursive --init
```

That will also get the submodules cloned. (`--recursive` is in case the submodules have submodules (!!)) and the `--init` does some necessary bookkeeping work in your local repo. How's that for a handwavy statement?)

And for now, that might be enough for you to get to work! All you really needed to build the existing project was the repo and its submodules, and you might not be in charge of the submodules and just need them to exist for the build. So now you can get to work.

But in case you need to do more, read on!

30.2 Creating a Submodule

Let's say you have a repo already, but you've decided you want to include another repo as a submodule.

Again, a use case for this might be if your main repo project depends on another one for the build, e.g. like a library. And you don't want to use the binary form of the library (or maybe it doesn't exist), so you need to build it.

If you didn't use submodules, anyone who wanted to build your repo would need to also clone the library repo and juggle all that. Wouldn't it be nicer if they could just add that `--recurse-submodules` flag to their `clone` command and have it all set up and ready to build?

So let's go through the steps of adding a submodule to an existing repo and see how that all works.

Feel free to use my sample repo as your submodule, use one of your own, or anyone else's. No one knows when you make a submodule out of their repo.

First, let's create a new repo for testing and put a commit in there for fun:

```
$ git init test_repo
Initialized empty Git repository in /frotz/test_repo/.git/
$ cd test_repo
$ echo Hello, world > foo.txt
$ git add foo.txt
$ git commit -m added
```

And let's add a submodule!

```
$ git submodule add \
    git@github.com:beejjorgensen/git-example-repo.git
Cloning into '/home/beej/tmp/test_repo/git-example-repo'...
remote: Enumerating objects: 4, done.
remote: Counting objects: 100% (4/4), done.
remote: Compressing objects: 100% (3/3), done.
remote: Total 4 (delta 0), reused 4 (delta 0), pack-reused 0 (from 0)
Receiving objects: 100% (4/4), done.
```

There you go! Well, almost, anyway. Let's check our status:

```
$ git status
On branch main
Changes to be committed:
  (use "git restore --staged <file>..." to unstage)
    new file:   .gitmodules
    new file:   git-example-repo
```

What are those things on the stage? Well, `git-example-repo` is the submodule. It's a little strange because Git is calling it a "file" when it's a directory, but that's just part of the special treatment submodules get.

And there's another file in there called `.gitmodules` that holds information about all the submodules you've added.

Both of these files (treating `git-example-repo` like a file) should be committed to your repo so that other people who clone it get the submodule information.

```
$ git commit -m "added submodule"
[main cede64] added submodule
 2 files changed, 4 insertions(+)
 create mode 100644 .gitmodules
```

```
create mode 160000 git-example-repo
```

Now you're set! Anyone who clones the repo gets that submodule information.

You can even do it with your test repo. Change directory to the parent of the test repo and clone it:

```
$ git clone --recurse-submodules test_repo test_repo2
```

After that you can `cd` into `test_repo2` and see the submodule there.

Can I Make a Local Repo a Submodule? No! Git prohibits that because there's some security risk there that, to be honest, I haven't really read about. There's supposed to be a way to override that with a config setting, which I thought would be quite useful for messing around to see how submodules worked, but apparently that config setting doesn't work as of late 2024. So you'll have to use `network-remote` repos for submodules.

30.3 Setting the Commit for the Submodule

What does this section even mean?

Here's the deal: the containing repo refers to a specific commit within the submodule. That is, the submodule is always checked out to a particular commit as defined in the containing repo. (The submodule `HEAD` might be attached to a branch, but it also very well might not be.)

The upshot of this is that when we make a repo with a submodule, we get to dictate which exact commit of that submodule our repo is using. And then, importantly, when someone clones our repo, they'll be looking at the submodule at the exact same commit as we are.

This lets us do things like choose a very particular version of a library as a submodule, and then everyone who clones our repo will get that same version *regardless of whether or not the submodule repo was changed elsewhere*. Someone else could move `main` wherever they want, but we'll still use the one commit we're pinned to, even if we fetch the new `main` commit into our submodule.

We effectively pin our submodule to a particular commit. And we probably want to do that so that someone else developing the submodule on the side doesn't introduce some change that breaks our containing repo's build.

How do we do that? It's pretty easy:

1. Go to the submodule directory.
2. Switch to the commit that you want to use. You can refer to this commit by branch name, commit hash, tag, or any other thing that `git switch` takes. Use `--detach` if you're detaching the `HEAD`.
3. Go back to the containing module directory.
4. Add the submodule directory.
5. Commit.

If you want to mess around with this using my test repos on GitHub, be sure to fork them first so you have write access.

Let's do the same thing we did in the last section and create the `test_repo` repo.

And then do the `clone` into `test_repo2` just so we have two to mess with. (Don't forget the `--recurse-submodules` flag!)

We're cloning a non-bare repo, which is weird. It's OK to clone it—the Git Police aren't going to show up. You just won't be able to push to it. And that's perfectly good enough for this demo. But it's something that you wouldn't normally do.

Also notice the detached HEAD in the cloned submodule repo! If you look in `test_repo2/git-example-repo` and do a `git log`, you'll see this on the first line:

```
(HEAD, origin/main, origin/HEAD, main)
```

See how `HEAD` is detached from `main`?

Now, I'd be lying if I said I knew the exact rules for when the `HEAD` in a submodule gets detached, but it's not uncommon. In fact, you should just generally assume it's detached and attach it to a branch if you have to. More on this later.

Now in `test_repo`, let's go into the submodule directory and check out an earlier version of the submodule repo. In this case, we'll just check out the previous commit from `main`.

```
$ cd test_repo/git-example-repo
$ git log
commit cd1bf77d2ef08115b18d7f15a9c172dace1b2222
    (HEAD -> main, origin/main, origin/HEAD)
Author: Brian "Beej Jorgensen" Hall <beej@beej.us>
Date:   Fri Dec 6 15:07:43 2024 -0800

    very important clarification

commit d8481e125e6ef49e2fa8041b16b9dd3b8136b550
Author: Brian "Beej Jorgensen" Hall <beej@beej.us>
Date:   Fri Dec 6 15:07:13 2024 -0800

    improve functionality

commit 433252748b7f9bf85e556a6a0196cdf38198fc43
Author: Brian "Beej Jorgensen" Hall <beej@beej.us>
Date:   Fri Jan 26 13:30:08 2024 -0800

    Added
```

Let's move this to the earlier commit.

```
$ git switch --detach d8481e
HEAD is now at d8481e1 improve functionality
```

So far so good. Now let's `cd` back to the containing repo and have a look at where we stand.

```
$ cd ..
$ git status
On branch main
Changes not staged for commit:
  (use "git add <file>..." to update what will be committed)
  (use "git restore <file>..." to discard changes in working
  directory)
    modified:   git-example-repo (new commits)

no changes added to commit (use "git add" and/or "git commit -a")
```

Look at that! The submodule directory is listed as modified. It says "new commits", but that's just telling us

that “things have changed in the submodule from the commit that I was pinned onto before”.

So let’s add that and commit it.

```
$ git add git-example-repo
$ git commit -m "update submodule commit"
[main dd69bb8] update submodule commit
 1 file changed, 1 insertion(+), 1 deletion(-)
```

And now let’s pull those changes in our clone, `test_repo2`—note the `--recurse-submodule` option on the pull!

```
$ cd ../test_repo2
$ git pull --recurse-submodules
Fetching submodule git-example-repo
Already up to date.
Submodule path 'git-example-repo': checked out
'd8481e125e6ef49e2fa8041b16b9dd3b8136b550'
```

And now on `test_repo2` if we jump into the `git-example-repo` submodule, we can check the log:

```
$ git log
commit d8481e125e6ef49e2fa8041b16b9dd3b8136b550 (HEAD)
Author: Brian "Beej Jorgensen" Hall <beej@beej.us>
Date:   Fri Dec 6 15:07:13 2024 -0800

    improve functionality

commit 433252748b7f9bf85e556a6a0196cdf38198fc43
Author: Brian "Beej Jorgensen" Hall <beej@beej.us>
Date:   Fri Jan 26 13:30:08 2024 -0800

    Added
```

And we see `HEAD` is on commit `d8481e`, just like we set it to in `test_repo`. (And we also do not see `main`. It’s the child commit from where `HEAD` is now, so it’s not appearing in the log. We could still switch to it if we wanted, of course.)

What have we done? We’ve changed the commit the submodule is pinned at in one repo, and then we’ve pulled that change into another repo!

30.4 Getting Submodule Latest

Let’s say someone else has updated the commit that the submodule is pinned at in your repo. And you want to get up to speed.

Two steps to make that happen:

1. In the containing repo, `git pull`. This will get you the latest version of the containing repo that has the new pinned commit numbers for the submodule.
2. In the containing repo (again), run:

```
git submodule update --init --recursive
```

This will fetch the submodule data and set you up to point at the correct commit.

30.5 Updating the Actual Submodule Itself

What do I mean by this? Let's say the submodule holds some library, and you need to make a bug fix in the library. And you need people who use this repo as a submodule (or otherwise) to get the changes.

So how to make this happen?

Either do it from a standalone repo, or you can also do it *in situ* in submodule directory.

30.5.1 Modify the Submodule Repo Elsewhere

The way that's easiest for my tiny human brain is to clone the submodule independently of any other repos. That is, clone it like it's not a submodule at all.

Then you can push, pull, modify, etc. all you want.

And then when you have it all fixed, you can go to the submodule directory and do a `git fetch` to pull down the new commits.

At that point, it might be convenient to run this:

```
$ git log HEAD^..origin/main
```

This will show you all the commits between `HEAD` and `origin/main`, inclusive so you can see what's been done. (Assuming they're related, that is. If they're on divergent branches you'll have to get more creative.)

Then you choose the commit you want to pin `HEAD` to, switch to that, and run an `add/commit` from the containing repo, as outlined in Setting the Commit for the Submodule, above.

30.5.2 Modify the Submodule Repo in the Submodule Directory

But wait! If the submodule is a full-blown repo itself, can't you just edit in the submodule directory?

Yes! You totally can.

The only weird part is that you might have a detached `HEAD` in your submodule, so be sure to check out a branch that you can push if you want to go this route.

For example:

```
$ git switch main
```

Then make your changes and push them (from the submodule directory).

At this point, the containing repo is still pinned to the old commit. So you'll want to run an `add/commit` from the containing repo, as outlined in Setting the Commit for the Submodule, above.

30.6 Getting the Submodule Status

When it comes to which commit the submodule is pinned to, there are some commands that are quite helpful.

The first is `git submodule status`. This will tell you where the submodule `HEAD` is currently.

For example, running from the containing repo:

```
$ git submodule status
898650e74c18cf4b30bdd07297d638de4a6fc7dd mysubmod (heads/main)
```

This tells me that `HEAD` in the `mysubmod` directory is at commit `89865`.

But what if you see this with a `+` sign in front:

```
$ git submodule status
+1c10d608190194b7f9fbb9a442abd5c63c74cdfa mysubmod (heads/main)
```

That `+` means that, although `HEAD` in the submodule is at commit `1c10d`, the containing repo has the submodule pinned to a different commit! You might see this happen after you pull a submodule (thus moving `HEAD`), but haven't updated the containing repo to match.

If you see the `+`, `git status` will also tell you more:

```
$ git status
On branch main
Changes not staged for commit:
  (use "git add <file>..." to update what will be committed)
  (use "git restore <file>..." to discard changes in working
  directory)
    modified:   mysubmod (new commits)

no changes added to commit (use "git add" and/or "git commit -a")
```

Sure enough—we have changed `HEAD` in the submodule so its directory shows as `modified`.

You can get rid of the plus by either pinning the repo to a new commit as outlined in [Setting the Commit for the Submodule](#), above, or by moving the submodule `HEAD` back to where the containing module expects it.

There can also be a `-` in front of the commit hash. This means the submodule hasn't been initialized or downloaded. Try a `git submodule update --recursive --init`.

How do we figure out where the containing module expects the submodule `HEAD` to be? With this handy command:

```
$ git ls-tree HEAD mysubmod
160000 commit 898650e74c18cf4b30bdd07297d638de4a6fc7dd mysubmod
```

30.7 Some Behind the Scenes

Not really behind the scenes, actually, but I wanted to point out the historic steps to initialize the submodule that we've shortcutted by using some command line switches.

For example, when we cloned the repo with the submodule initially, we used this:

```
$ git clone --recurse-submodules \
  git@github.com:beejorgensen/git-example-submodule-repo.git
```

That `--recurse-submodules` did a lot of work for us, cloning the submodule and setting everything up so it was ready to use.

We also noted that if we forgot that switch, we could still pull it off:

```
$ git clone \
    git@github.com:beejjorgensen/git-example-submodule-repo.git
$ cd git-example-submodule-repo
$ git submodule update --recursive --init
```

So `--recurse-submodules` was going that work for us.

But the rabbit hole goes farther! That `--init` does a bunch for us, too. Let's break it down into a full by-hand process. Don't worry—it's just a couple steps:

```
$ git clone \
    git@github.com:beejjorgensen/git-example-submodule-repo.git
$ cd git-example-submodule-repo
$ git submodule init
$ git submodule update --recursive
```

So that `--recurse-submodules` switch to `git clone` was actually running a bunch of commands for us behind the scenes.

A little breakdown:

When you first clone the containing repo, there's a `.gitmodules` file in there indicating the directory name and the URL of the submodule remote. But that's not enough info. You have to do a `git submodule init` to cause Git to parse that file and set up some internal bookkeeping.

After that, you can run `git submodule update` to bring in the submodule data to use.

30.8 Deleting a Submodule

This is a bit clunky, but not too bad if you follow the steps.

All this action takes place from the containing repo. Let's say for this example we want to delete the module `mysubmod`—substitute the name of your module in the following commands.

1. De-initialize the submodule. If the submodule `HEAD` is not where the containing module expects, you can add `-f` to force this.

```
$ git submodule deinit mysubmod
```

This is partially undoing `git submodule init`.

2. Remove the bookkeeping information from the Git internals for the containing repo.

```
$ rm -rf .git/modules/mysubmod
```

This is the rest of undoing `git submodule init`.

3. Fix up `.gitmodules` by removing the section about the submodule. You can either do this by hand in an editor, or you can ask Git to do it like so:

```
$ git config -f .gitmodules --remove-section submodule.mysubmod
```

This is undoing `git submodule add`.

4. Add the `.gitmodules` file to the stage.

```
$ git add .gitmodules
```

5. Delete the submodule tree from Git. This will also add the deletion to the stage.

```
git rm --cached mysubmod
```

This is sort of like undoing `git submodule update`.

6. Do a `git status` to make sure we're set.

```
$ git status
On branch main
Changes to be committed:
  (use "git restore --staged <file>..." to unstage)
        modified:   .gitmodules
        deleted:    mysubmod
```

Looks good.

7. Commit and push (if appropriate).

```
$ git commit -m "remove mysubmod submodule"
$ git push
```

And that's the end of the submodule.

Chapter 31

Tags

Tags are a way to annotate a particular commit. You can kind of think of them like branches that don't move.

A very common case is to take a particular commit with a version number like `1.2.3`.

I can't find any rules about what characters you can use in tag names, but it seems safe to use ASCII upper and lower case, numbers, and punctuation like `.`, `-`, and `_`, etc.

There are two types of tags:

- **Lightweight:** Just a tag, e.g. `v3.14`.
- **Annotated:** Also a tag, e.g. `v3.14`, but includes a message and author, like a commit.

You can generally use tags the same way you'd use branches (you can diff them, switch to them, etc.) except they don't move.

And you can see them in the log with the other branch information.

```
commit 4fa1199d17a97990a7721eb8a73a4ee50 (HEAD -> main, tag: v3.14)
Author: User <user@example.com>
Date:   Sat Jan 25 19:04:43 2025 -0800

    Update the stuff

commit c265e0371b3fc11588e4183b35e0b96e3 (tag: v3.10)
Author: User <user@example.com>
Date:   Sat Jan 25 18:59:58 2025 -0800

    Add the stuff
```

Or get a list of all tags with just `git tag`.

31.1 Lightweight Tags

Adding a lightweight tag is easy enough. First, switch to the commit you want to tag, and then run this, assuming you want a tag called `tagname`:

```
$ git tag tagname      # Tag HEAD commit with tagname
```

You can also tag a commit, or anything that refers to a commit (like a branch or even another tag):

```
$ git tag CPE1704TKS 4fa12    # tag commit 4fa23
$ git tag plover feature99    # tag branch feature99
```

31.2 Annotated Tags

Adding an annotated tag is just about as easy. Add the `-a` for “annotate” switch.

Since an annotated tag is more like a commit, it’s going to prompt for a message. But you can also use `-m` to specify it on the command line.

```
$ git tag -a v3490    # tag HEAD commit with v3490
```

Or if you want to specify the message on the command line:

```
$ git tag -a v3490 -m "tag message"
```

31.3 Pushing Tags

By default, the tags only exist on your local repo, even if you do a regular push. You have to tell it you want to push tags explicitly.

If you want to push all new tags, you can:

```
$ git push --tags
$ git push origin --tags # Or you can specify a remote
```

If you want to just push one tag, you must specify the remote:

```
$ git push origin tag3.14
```

After a tag is pushed, other collaborators will automatically get the tags when they pull.

31.4 Deleting Tags

You can delete a tag on your repo like this:

```
$ git tag -d tagname
```

And that’s easy enough. Except if you’ve already pushed on the server. If you have, then the next time you pull you’ll get the tag again.

So you’ll have to delete the one on the remote, as well, which also must be named explicitly:

```
$ git push origin -d tagname
```

That’ll delete the tag on the server, but *it won’t delete it from other people’s clones*. In fact, there’s no easy way to do this.

The basic idea is that tags, once created, shouldn’t be deleted. Now, if you haven’t yet pushed, no problem. Add, delete, and change all you want. But once you’ve pushed (and someone has pulled), if you need to change a tag, just make a new tag.

That's not a law; it's just more of a recommended guideline.

Chapter 32

Worktrees

Let's say you have your code in one window and you're happily looking at `main`. And then you think, "It would be nice to look at some files on `foobranch` for a moment."

But you're in the middle of something on `main`. So you go through the trouble of saving, stashing, switching to `foobranch`, looking at what you need, and then switching back, popping the stash, and editing your file.

And then precisely 2.3 seconds later, you realize you need to look at `foobranch` again. Gah.

You can't have two branches checked out in the same working tree at the same time. So what are you supposed to do if you want to look at both at once?

Sure, you can make another clone, but that might be prohibitive if the amount of data in the clone is large. You could do a shallow clone... but now it just feels hackish.

Turns out *worktrees* give us a better way. With `git worktree`, you can make another, separate working tree at a different branch. And then looking at both of them is just a matter of `cd` or having two terminal windows open at the same time.

32.1 Worktree Rules and Regulations

Let's put a quick note here about some ground rules.

1. No two worktrees (on the same repo) may refer to the same branch at the same time. That is, all worktrees must refer to different branches. If you try to switch to, say, `main` on two worktrees simultaneously, Git will stop you.
2. You can put the new worktree anywhere you want. But my strong recommendation is that you place it *outside* the existing working tree, as a sibling directory.
3. You can run all regular Git commands from any of the working trees, including committing, pushing, and pulling.
4. A worktree is **not** a clone. It's another view into the repo. Commits made in one working tree are immediately available (but not automatically switched to) in the other because both working trees are looking at the same local repo! (Unlike a clone where two clones would be associated with the same *remote* repo.)
5. Only one of the worktrees is the *real* one (called the "main working tree", no relation to the `main` branch). The others don't have a proper `.git` directory. Do not delete the real one unless you want to lose all your git metadata! Always use `git worktree remove` to remove worktrees because it'll refuse to remove the main one if you foolishly try to do so.

With that boring legalese out of the way, let's get something going!

32.2 Making a New Worktree

Let's say you're in the root of a repo called `wumpus` on branch `main`. And you want to look at another branch called `arrow` in a new working tree.

We're going to use `git worktree add` and we're going to give it two things.

1. The directory name of where the worktree should go. Since I'm checking out the `arrow` branch on the `wumpus` repo there, I'm going to just call it `../wumpus-arrow`. You could call it anything, though.

Also note the `../`; that's to get us to the parent directory so that `wumpus-arrow` will be created as a sibling directory to `wumpus`.

2. We also need to give it the branch to switch to in that worktree. Again, this can't be a branch that's checked out in any other working tree.

Let's do it!

```
$ git worktree add ../wumpus-arrow arrow
Preparing worktree (checking out 'arrow')
HEAD is now at 7da9b7f fix arrow flight
```

There we have it. We can now `cd` to that directory and look around.

```
$ cd ../wumpus-arrow
$ git status
On branch arrow
nothing to commit, working tree clean
```

Or you could have two windows open. One would be in the `wumpus/` directory to see branch `main`, and the other would be in the `wumpus-arrow/` directory to see branch `arrow`.

32.3 Removing a Worktree

First, make sure you don't have any uncommitted modifications in the condemned worktree. Then figure out the path to it. And then remove it.

Let's say we're in the `wumpus/` directory from the previous example. From there, I could delete the `wumpus-arrow/` worktree like so:

```
$ git worktree remove ../wumpus-arrow
```

And that would be that.

Again, this doesn't delete any commits that you made from that worktree; the worktree is just a view onto the same repo as the main working tree, so the commits are already stored in the repo the instant you make them from any of the worktrees.

The path you specify for `worktree remove` doesn't have to match character-for-character the one you specified with `worktree add`. It just has to refer to the same directory.

For example, if I were in the `wumpus/` directory, this would accomplish the same thing as the first example:

```
$ cd ..
$ git worktree remove wumpus-arrow
```

You can even blow away the worktree you're in right now:

```
$ git worktree remove .
```

And, finally, if you try to remove the main working tree, you're stopped by the Git police.

```
$ git worktree remove wumpus
fatal: 'wumpus' is a main working tree
```

32.4 Listing Worktrees

You can see all your worktrees and determine which one is the main working tree with the `worktree list` command.

```
$ git worktree list
/home/user/wumpus          30d669a [main]
/home/user/wumpus-arrow   7da9b7f [arrow]
```

That'll show you all the working trees with their directories on the left, their commit hashes in the middle, and the branch names on the right.

The first worktree listed is the main working tree, i.e. the one you can't remove.

32.5 Worktrees and Detached HEAD

You can't have the same branch checked out in two worktrees on the same repo because that would mean two worktrees would be fighting over the placement of a single branch reference.

However, both worktrees do have their own HEAD! There's no conflict there. So you could have one worktree on `main` and the other with a detached HEAD on the same commit as `main`. Of course, any commits on the detached HEAD won't move `main` at all, so there's no conflict.

```
$ cd ../wumpus-arrow

$ git switch --detach main
HEAD is now at 30d669a add drafts

$ git worktree list
/home/user/wumpus          30d669a [main]
/home/user/wumpus-arrow   30d669a (detached HEAD)
```

In that example, we see both worktrees are pointed at the same commit `30d669a` but we're OK since they're not checked out at the same branch.

You can also add a new worktree with a detached HEAD like in the next example where we detach the new worktree's HEAD at the `main` commit.

```
$ git worktree add --detach ../wumpus-worktree main
```

Finally, if you specify a commit hash instead of branch when creating a new worktree, it will be automatically be created with a detached `HEAD`.

Chapter 33

Appendix: Making a Playground

In programming circles in general, a *playground* is a place you can go to mess with code and tech and not worry about messing up your production system.

And there are places you can go online to find these, but with Git, I find it's just as easy to make your own local repo.

Here's a way to make a new local repo called `playground` out of the current directory. (You should **not** be under a Git repo at this time; create the playground outside other existing repos.)

```
$ git init playground
Initialized empty Git repository in /user/playground/.git/
```

`playground` isn't a special name. You can call it `foo` or anything. I'll just use it for this example.

What that command did was create a new subdirectory called `playground` and create a Git repo in it.

Let's continue at the end: how do you delete the repo? You just remove the directory.

```
$ rm -rf playground # delete the playground repo
```

And let's create it again:

```
$ git init playground
```

We have all the power!

This repo only exists on this computer; it has no remotes and no way to push. You could add that stuff later, if you wanted, but playgrounds tend to be temporary areas where you're just trying things out.

Let's go into the playground and check it out.

```
$ cd playground
$ ls -la
total 4
drwxr-xr-x  3 user group  18 Jul 13 14:43 .
drwxr-xr-x 22 user group 4096 Jul 13 14:43 ..
drwxr-xr-x  7 user group  119 Jul 13 14:43 .git
```

There's a directory there called `.git` that has all the metadata in it.

If we wanted to change this directory from a Git repo to just a normal directory, we could run this:

```
$ rm -rf .git      # Delete the .git directory
```

Again, we have all the power! But let's show some restraint and not do that yet.

What can we do?

What *can't* we do? Let's make a file and see where we stand:

```
$ echo "Hello, world" > hello.txt  # Create a file

$ ls -l

total 4
-rw-r--r-- 1 user group 13 Jul 13 14:47 hello.txt

$ git status

On branch main

No commits yet

Untracked files:
  (use "git add <file>..." to include in what will be committed)
  hello.txt

nothing added to commit but untracked files present (use "git
add" to track)
```

Now we have an untracked file.

We can `git add` it, we can `git commit` it, we can create branches, we can merge them and make conflicts and resolve them and `git rebase` and `git reset` and all kinds of stuff.

We don't have a remote, so the only things we can't do involve pushing and pulling.

But it turns out we can even make that happen! Let's see how.

33.1 Cloning Bare Repos

A *bare repo* is one without a working tree. You can't go in there to see files, because they don't exist in there in a normal sense. The only thing that's there is metadata and the commit snapshots.

You can clone, push, and pull bare repos.

Let's make one (again, you could name it anything you want), noting the `--bare` command line option:

```
$ git init --bare origin_repo
Initialized empty Git repository in /user/origin_repo/
```

If you look in there (to be clear, you have no reason to) you'll just see metadata and directories.

Before we can use it, we'd better clone it. For ease, we'll do this from the same directory we created it.

```
$ git clone origin_repo playground
Cloning into 'playground'...
warning: You appear to have cloned an empty repository.
done.
```

It is empty, naturally. We haven't made any commits.

Now we have two repos in this directory:

- `origin_repo`: the bare repo we cloned, and:
- `playground`: the repo we cloned from it.

Let's jump in there and see what's up:

```
$ cd playground
$ git remote -v
origin    /user/origin_repo (fetch)
origin    /user/origin_repo (push)
```

We have remotes! Of course we do. We cloned this repo, and Git automatically sets up the `origin` remote.

And remember that `origin` is just an alias for some remote that's identified somehow. We're used to seeing remotes that start with `https` or `ssh`, but here's an example of a remote that's just another subdirectory on your disk.

Let's make a file and commit it, and see if we can push!

```
$ echo "Hello, world" > hello.txt
$ git add hello.txt

$ git commit -m added
[main (root-commit) 4a82a14] added
 1 file changed, 1 insertion(+)
 create mode 100644 hello.txt

$ git push
Enumerating objects: 3, done.
Counting objects: 100% (3/3), done.
Writing objects: 100% (3/3), 907 bytes | 907.00 KiB/s, done.
Total 3 (delta 0), reused 0 (delta 0), pack-reused 0 (from 0)
To /user/origin_repo
 * [new branch]      main -> main

$ git branch -va
* main                4a82a14 added
remotes/origin/main 4a82a14 added
```

And we've successfully pushed our file up to `origin`.

Finally, let's make another clone. First we'll `cd` back down to where `origin_repo` is and clone again this time into `playground2`:

```
$ git clone origin_repo playground2
Cloning into 'playground2'...
done.
```

Let's `cd` in there and see what we have. It's a clone of the repo, so we'd better see the `hello.txt` we pushed in there from `playground` earlier.

```
$ cd playground2
$ ls
  hello.txt
$ cat hello.txt
Hello, world
```

Voila! It's there!

Since `playground` and `playground2` are both clones of the same repo, you can push from one and pull from the other to get the changes.

You can even make conflicting changes and try to `git pull` or `git pull --rebase` and see how things go wrong and how to fix them.

And if everything goes completely off the rails, you can just delete the directories and start again. It's a playground!

33.2 Automating Playground Builds

It can be tedious to continually destroy and recreate repos that you're trying to learn from. I suggest putting your commands in a *shell script*, which is just a text file that contains the commands to run.

Let's say you make a new text file called `buildrepo.sh` and you put the following text in it:

```
rm -rf playground # Remove old playground
git init playground # Create a new one
cd playground
echo "Hello, world!" > hello.txt # Create hello.txt
echo "foobar" > foobar.txt # Create foobar.txt
git add hello.txt foobar.txt
git commit -m added
echo "foobar again" >> foobar.txt # Append text
git add foobar.txt
git commit -m updated
```

That's just a bunch of shell commands. But here's the fun bit: if you run `sh` (the shell) with `buildrepo.sh` as an argument, it will run all those commands in order!

```
$ sh buildrepo.sh
Initialized empty Git repository in /user/playground/.git/
[main (root-commit) 2239237] added
 2 files changed, 2 insertions(+)
 create mode 100644 foobar.txt
 create mode 100644 hello.txt
[main 0533186] updated
 1 file changed, 1 insertion(+)
```

To debug a shell script you can run it like this: `sh -x buildrepo.sh` and it will show you the commands it is running.

After that, we can `cd` in there and see what happened:

```
$ cd playground
$ git log
commit 05331869d77973dfbac38a31c40a44f99225e85d
Author: User Name <user@example.com>
Date:   Sat Jul 13 15:19:42 2024 -0700

    updated

commit 2239237cc44d11e9479dcc610e5d02ad283766ce
Author: User Name <user@example.com>
Date:   Sat Jul 13 15:19:41 2024 -0700

    added

$ cat foobar.txt
foobar
foobar again
```

By putting the initialization commands in a shell script, it's almost like having a "saved game" at that point. You can just rerun the shell script any time you want the same playground set up.

Chapter 34

Appendix: Getting Out of Editors

If you try to `git commit` and don't specify `-m` for a message, or if you `git pull` and there's a non-fast-forward merge, or if you `git merge` and there's a non-fast-forward merge and you don't specify `-m`, or what I'm sure are a host of other reasons, you might get popped into an editor.

And you might not be familiar with that editor.

So here's how to get out of it.

- **Nano:** If the editor says “Nano” or “Pico” in the upper left, then edit the commit message (if you want), then then hit `CTRL-X`, and then hit `Y` to save, then `ENTER` to accept the given filename.
- **Vim:** If the screen has a bunch of `~` characters down the left and a crazy-looking file name at the bottom maybe with the word `ALL`, you're in Vim or some other `vi` (“vee eye”) variant. Press `i`, then type a message (if you want), then hit the `ESC` key in the upper left, then type two capital `Zs` in a row. `ZZ`. That should save and exit.

I love Vim. But it took a while. If you want to learn more, see the Appendix on Using Vim, that has the briefest of tutorials. I guess the previous paragraph was really the briefest, so we'll call it the second-briefest.

Chapter 35

Appendix: Errors and Scary Messages

35.1 Detached Head

Did you get this alarmingly guillotinesque message?

```
You are in 'detached HEAD' state. You can look around, make
experimental changes and commit them, and you can discard any
commits you make in this state without impacting any branches by
switching back to a branch.
```

```
If you want to create a new branch to retain commits you create,
you may do so (now or later) by using -c with the switch command.
Example:
```

```
git switch -c <new-branch-name>
```

```
Or undo this operation with:
```

```
git switch -
```

```
Turn off this advice by setting config variable advice.detachedHead
to false
```

```
HEAD is now at 0da5af9 line 1
```

This means that you've checked out a commit directly instead of checking out a branch. That is, your **HEAD** is no longer attached to a branch, i.e. it is "detached".

To get out of this, you can:

1. Undo the checkout that got you detached:

```
git switch -
```

2. Switch to another branch entirely:

```
git switch main
```

3. Make a new branch here and check it out:

```
git switch -c newbranch
```

And now your `HEAD` is no longer detached.

35.2 Upstream Branch Name Doesn't Match Current

Did you accidentally run `git branch -c newbranch` when you meant to run `git switch -c newbranch`? Because if you did, it could land you here:

```
fatal: The upstream branch of your current branch does not match
the name of your current branch. To push to the upstream branch
on the remote, use
```

```
git push origin HEAD:main
```

To push to the branch of the same name on the remote, use

```
git push origin HEAD
```

To choose either option permanently, see `push.default` in `'git help config'`.

To avoid automatically configuring an upstream branch when its name won't match the local branch, see option `'simple'` of `branch.autoSetupMerge` in `'git help config'`.

Let's check our branch names to see what's going on:

```
$ git branch -vv
main          fc645f2 [origin/main] line 2
* newbranch   7c21054 [origin/main: behind 1] line 1
```

That tells us our local branch names and, in brackets, the corresponding remote-tracking branch. Notice anything fishy?

It seems `main` corresponds with `origin/main`.

And that `newbranch` **also** corresponds with `origin/main`! How?!

Well, when you did `git branch -c newbranch`, that *copies* the current branch (`main` in this example) into the other branch, *including its remote-tracking branch*. Bad news, since you really want `newbranch` to correlate to `origin/newbranch`, if anything.

You have a few options.

1. You want to push `newbranch` up to the `origin` and track it as `origin/newbranch`.

Just do this to push and change the remote-tracking branch name:

```
$ git push -u origin newbranch
```

2. You just want this to be a local branch and don't need it on the remote.

In this case, just unset the upstream:

```
$ git branch --unset-upstream newbranch
```

35.3 Current Branch Has No Upstream Branch

Trying to push and getting this message?

```
fatal: The current branch topic1 has no upstream branch.  
To push the current branch and set the remote as upstream, use
```

```
git push --set-upstream origin topic1
```

```
To have this happen automatically for branches without a tracking  
upstream, see 'push.autoSetupRemote' in 'git help config'
```

This just means there's no upstream tracking branch for `topic1`—it's just a local branch.

If you do want to push this branch, just follow the suggested instruction.

If you are pushing from the wrong branch by accident, switch to the right one first.

Chapter 36

Appendix: Just Enough Vim

Vim¹ is a very-commonly installed editor with a steep learning curve.

This appendix is here just to give you enough Vim to be dangerous!

36.1 Launching Vim

It could be you found yourself in Vim because you were committing and you didn't use `-m` to specify a message. You'll know it if you see some `~` characters down the left and some kind of status bar at the bottom.

Or you might have launched it yourself with something like this, to edit `foo.c`:

```
$ vim foo.c
```

36.2 Modal Editing

Vim primarily exists in two modes:

- **Insert Mode:** This is the mode where you're pressing keys and the corresponding letters appear in your document, just like you expect from any normal editor.
- **Normal mode:** This is the special Vim mode that you're not familiar with in virtually all other editors. In this mode, keys have special meaning. For example, the `h` key moves the cursor one character to the left.

The editor starts in normal mode! This is why when you get dumped into it none of the keys do what you want.

The power of Vim comes from memorizing *tons* of Normal Mode commands. This allows you to move the cursor and edit at speed. The vimhelp website has a reference of all the normal mode commands², just to give you a rough idea of what's available.

But at first, when you barely know any Normal Mode commands, modal editing just seems to get in the way. But as you get better at it, you'll see it's actually a really powerful feature.

¹<https://www.vim.org/>

²<https://vimhelp.org/index.txt.html#normal-index>

36.3 Going Between Modes

Here are the two main modes:

- To get from *normal mode* to *insert mode*, press `i`.
- To get from *insert mode* back to *normal mode*, press `ESC`. (That’s the “escape” key in the upper left of the keyboard.)

There! You’ve learned one normal mode command! `i` to insert some text!

| **Try it:** launch Vim, type `i`, then type `hello world!`, then hit `ESC` to get back to normal mode.

36.4 Moving the Cursor

You can probably use the cursor keys. In fact, your version of Vim might even allow you to use them without ever leaving insert mode.

Real Vim users move the cursor in normal mode with the following keys.

- Up: `k`
- Down: `j`
- Left: `h`
- Right: `l`

Muscle memory will eventually take over with these.

If you’re in insert mode, the delete key should generally work as expected, as well.

36.5 More Modes

I said there were two main modes, but there are actually more. Here are two more bonus modes:

- To get from *normal mode* to *command-line mode*, press `:`. More on this, below.
- To get from *normal mode* to *search mode*, enter `/`. Type a string to search for.

36.6 Command Line Mode

As mentioned earlier, if you’re in normal mode, you can hit `:` to get to *command line mode*.

This moves the cursor to the bottom of the screen and allows you to type a command there.

So from now on in this chapter, when I say something like `:q!`, that means to type those three characters from normal mode.

If you get into command line mode and want to get back to normal mode, just press return without entering a command.

36.7 Exiting Vim

There are a few ways, and all of them start from normal mode. (So hit `ESC` after you’re done entering text, then try to exit.)

- `ZZ` — exit, saving only if there have been changes
- `:wq` — exit, saving unconditionally (“write, quit”)
- `:q` — exit, don’t save
- `:q!` — exit, don’t save even if there have been changes!

And one more that's of use for Git:

- `:cq` — exit with a non-zero (AKA error) exit status

If you do a `:cq` when entering a commit message in Vim, Git will think something went wrong and not complete the commit. So if you find yourself in Vim writing a commit message and think, “I didn't mean to do this yet!” you can `:cq` to get out of it. The files will remain on the stage.

36.8 Learn More

If you have Vim installed, you already have Vim Tutor installed! This is just a file that gets opened and directs you through using and learning vim.

Launch it with:

```
$ vimtutor
```

If you don't feel like messing with it right now, you can just `:q!` to quit.

There's also an interactive online tutorial called OpenVim³ that gets you through the first steps.

Finally, ChatGPT⁴ or other AIs will be helpful in finding new normal mode commands and answering questions.

“This your last chance. After this there is no turning back. You take the blue pill, the story ends. You wake up using your normal editor and edit files whatever way you want to. You take the red pill, you stay in Vim and I show you how deep the rabbit hole goes.”

—With apologies to Morpheus, *The Matrix*

³<https://openvim.com/>

⁴<https://chatgpt.com/>

Chapter 37

Appendix: Other References

“Your book stinks. What other references can I use?”

Here are more! I found these by searching the Internet for Git book recommendations. The only ones I’ve used are the man pages and *Pro Git*.

- **The man pages**

- If you have the manual pages (historically known as the “man pages”) installed on your system, and you probably do, you can get help for particular Git commands right from the command line. For example, if you want to know about `git config`, you can type:

```
$ man git-config
```

(The minus between “git” and “config” might or might not be required depending on your system, but I’ve never found a place where it doesn’t work.)

Once you’re in there, the arrow keys, space bar, and page up/down probably work to navigate, and hitting `q` or `Escape` probably quits. It depends on the pager your system uses.

These manual pages are very comprehensive, and don’t tend to be easy to read. But all the information is there! They can also be found in *The Git Reference Manual*, below.

- **Free Stuff!**

- *Pro Git*¹—The Book
- *The Git Reference Manual*²
- *The Git Community Book*³
- *git cheat sheet*⁴
- *Oh Shit, Git!?!?*⁵
- *Learn Git Branching*⁶
- *GitHub Learning Lab*⁷
- *Learn Git and GitHub*⁸
- *Learn Git*⁹
- *Git Immersion*¹⁰

¹<https://git-scm.com/book/en/v2>

²<https://git-scm.com/docs>

³<https://shafiul.github.io/gitbook/index.html>

⁴<https://wizardzines.com/git-cheat-sheet.pdf>

⁵<https://ohshitgit.com/>

⁶<https://learnitbranching.js.org/>

⁷<https://github.com/apps/github-learning-lab>

⁸<https://www.codecademy.com/learn/learn-git>

⁹<https://www.atlassian.com/git/tutorials>

¹⁰<https://gitimmersion.com/>

- *Git Internals*¹¹
- *Post-Production Editing Using Git*¹²
- **For Money**
 - *How Git Works*¹³
 - *Oh Shit, Git*¹⁴
 - *Learn Git in a Month of Lunches*¹⁵
 - *Getting Started with GitHub*¹⁶
 - *Git Pocket Guide*¹⁷
 - *Version Control with Git*¹⁸
 - *Git in Practice*¹⁹
 - *Git for Teams*²⁰
 - *Pragmatic Version Control using Git*²¹
 - *Mastering Git*²²

If you know of more, mail them to beej@beej.us.

¹¹<https://github.com/pluralsight/git-internals-pdf?tab=readme-ov-file>

¹²<http://sethrobertson.github.io/GitPostProduction/gpp.html>

¹³<https://wizardzines.com/zines/git/>

¹⁴<https://wizardzines.com/zines/oh-shit-git/>

¹⁵<https://www.manning.com/books/learn-git-in-a-month-of-lunches>

¹⁶<https://www.amazon.com/Introducing-GitHub-Non-Technical-Peter-Bell/dp/1491949740>

¹⁷<https://www.amazon.com/Git-Pocket-Guide-Working-Introduction/dp/1449325866>

¹⁸<https://www.amazon.com/Version-Control-Git-collaborative-development/dp/1449316387>

¹⁹<https://www.amazon.com/Git-Practice-Techniques-Mike-McQuaid/dp/1617291978>

²⁰<https://www.amazon.com/Git-Teams-User-Centered-Efficient-Workflows/dp/1491911182>

²¹<https://pragprog.com/titles/tsgit/pragmatic-version-control-using-git/>

²²<https://www.amazon.com/Mastering-Git-proficiency-productivity-collaboration/dp/1783553758>

Chapter 38

Quick Reference

Quickly look up commands based on what you want to do! Caveat: this list is grotesquely incomplete! See your man pages for more info!

In this reference section we use the following substitutions:

- **URL**: Some URL either SSH, HTTP, or even a local file, usually the URL you cloned from.
- **FILE**: Path to file, e.g. `foo/bar.txt`, etc.
- **DIR**: Path to directory, e.g. `foo/`, etc.
- **PATH**: Path to directory or file
- **BRANCH**: Some branch name, e.g. `main`, etc.
- **REMOTE**: A remote name, e.g. `origin`, `upstream`, etc.
- **HASH**: Some commit hash—you can get a commit hash from `git log` or `git reflog`.
- **CMMT**: a commit hash, branch, etc. Anything that refers to a commit. Officially this is called a *tree-ish*, but that was more letters than I wanted to repeatedly type.
- **VARIABLE**: a Git config variable name, usually words separated by periods.
- **VALUE**: an arbitrary value for Git configs.
- **TAG**: a tag name

Also, don't type the `$`—it's the shell prompt. And everything after a `#` is a comment. A backslash `\` at the end of a line indicates that it continues on the next line.

38.1 Glossary

- **Clone**: a duplicate (or to duplicate) a remote repo, commonly for local use.
- **Commit**: a snapshot of all the files in the repo at a point in time.
- **Fork**: a GitHub construct to make a clone of someone else's GitHub repo under your GitHub account.
- **HEAD**: the commit that is currently checked out/switched to.
- **Index**: another name for the *stage*.
- **main**: a common the first branch created.
- **master**: another common name for the first branch created.
- **origin**: the default name for the remote from which this repo was cloned.
- **Pull request**: a way to get changes you made in your fork of a repo back into the repo you forked from.
- **Remote**: an alias for a URL to another repo. Usually an HTTP or SSH URL.
- **Stage**: where you collect files to be bundled into a commit.
- **upstream**: the conventional name of the remote that you forked from. Not set up automatically.
- **Working Tree**: the collection of files you can see, which might have changes from the commit at **HEAD**.

- **WT**: shorthand for working tree.

38.2 File States

- **Untracked** to:
 - Unmodified: `git add FILE`
- **Unmodified** to:
 - Modified: Edit with your editor and save
 - Untracked/deleted: `git rm --cached FILE`
- **Modified** to:
 - Staged: `git add FILE`
 - Unmodified: `git restore FILE` (discards changes)
 - Untracked/deleted: `git rm --cached FILE`
- **Staged**
 - Unmodified: `git commit FILE` (finalize commit)
 - Modified: `git restore --staged FILE` (unstage)
 - Both modified: `git checkout --merged FILE` (during merge)

38.3 Configuration

For all `git config` commands, specify `--global` for a universal setting or leave it off to set the value just for this repo.

```
$ git config set VARIABLE VALUE
$ git config get VARIABLE
$ git config list
$ git config unset VARIABLE
$ git config --edit
```

38.3.1 Set identity

Username and email:

```
$ git config set --global user.name "Your Name"
$ git config set --global user.email "your-email@example.com"
```

SSH identity:

```
$ git config set core.sshCommand \
"ssh -i ~/.ssh/id_alterego_ed25519 -F none"
```

38.3.2 Set default branch

This is the first branch created when you make a new repo.

```
$ git config set --global init.defaultBranch BRANCH
```

Common names are `main`, `master`, `trunk`, and `development`. This guide uses `main`.

38.3.3 Set default pull behavior to merge or rebase

```
$ git config set --global pull.rebase false # Merge
$ git config set --global pull.rebase true # Rebase
```

38.3.4 Set default editor, difftool, and mergetool

Set the default editor to Vim, and the default mergetool and difftool to Vimdiff, turn off prompting for the tools, and turn off mergetool backups:

```
$ git config set core.editor vim
$ git config set diff.tool vimdiff
$ git config set difftool.prompt false
$ git config set difftool.vimdiff.cmd 'vimdiff "$LOCAL" "$REMOTE"'
$ git config set merge.tool=vimdiff
$ git config set mergetool.vimdiff.cmd \
    'vimdiff "$LOCAL" "$REMOTE" "$MERGED"'
$ git config --global set mergetool.keepBackup false
```

38.3.5 Colorful Git output

```
$ git config set color.ui true # Or false
```

38.3.6 Autocorrect

Autocorrect will automatically run the command it thinks you meant. For example, if you `git poush`, it will assume you meant `git push`.

```
$ git config set help.autocorrect 0 # Ask "Did you mean...?"
$ git config set help.autocorrect 7 # Wait 0.7 seconds before run

$ git config set help.autocorrect immediate # Just guess and go
$ git config set help.autocorrect prompt # Prompt then go
$ git config set help.autocorrect never # Turn autocorrect off
```

38.3.7 Newline translation

Handle automatic newline translation. Recommend set to true for Windows (not WSL) and false everywhere else.

```
$ git config set core.autocrlf true # Windows (non-WSL)
$ git config set core.autocrlf false # WSL, Linux, Mac, C64, etc.
```

Obsolete commands for older versions:

```
git config user.email # Get
git config user.email "user@example.com" # Set
git config --unset user.email # Delete
git config --list # List
git config --edit # Edit
```

38.3.8 Aliases

Setting aliases, some examples:

```
$ git config set --global alias.logn 'log --name-only'
$ git config set alias.aa "add --all"
$ git config set alias.logc "log --oneline --graph --decorate"
$ git config set alias.diffc "diff --staged"
$ git config set alias.lol "log --graph"
" --pretty=format:'%Cred%%Creset -%C(yellow)%d%Creset %s"\
"%Cgreen(%cr) %C(bold blue)<an>%Creset' --abbrev-commit"
```

Getting aliases:

```
$ git config get alias.logx
$ git config get --all --show-names --regexp '^alias\.'
$ git config set alias.aliases \
  "config get --all --show-names --regexp '^alias\.'"
```

Tracing an alias run:

```
$ GIT_TRACE=1 git logx
```

38.4 Creating and Cloning Repos

```
$ git clone URL           # Clone a URL
$ git clone URL DIR       # Clone a URL to directory
$ git init DIR            # Init repo at directory
$ git init .              # Init repo in the current directory
```

38.5 Adding, Renaming, Deleting, Committing

```
$ git add PATH           # Add PATH to the repo
$ git mv FILE1 FILE2     # Rename ("Move") FILE1 to FILE2
$ git mv FILE2 FILE1     # Undo the above rename
$ git rm FILE            # Delete ("Remove") FILE
$ git add -p FILE        # Add file in patch mode

$ git commit             # Commit files on stage
$ git commit -m "message" # Commit with a message
```

Amending commits—don't amend commits you have pushed unless you know what you're getting into!

```
$ git commit --amend      # Amend last commit
$ git commit --amend -m "message" # Amend with commit message
$ git commit --amend --no-edit # Don't change commit message
```

To undelete a staged file, run these two commands in sequence:

```
$ git restore --staged FILE
$ git restore FILE
```

To undelete a deleted file, you could manually recover it from an old commit, or revert the commit that deleted it.

38.6 Getting Status

```
$ git status          # Show current file states
$ git log             # Show the commit logs
$ git log --name-only # Also list changed files
$ git log CMMT       # Show log from a specific branch
$ git log CMMT1 CMMT2 # Show logs from multiple branches

$ git log CMMT1..CMMT2 # Show logs from CMMT2 since it
                       # diverged from CMMT1
$ git log CMMT1...CMMT2 # Show logs from CMMT1 and CMMT2
                       # since they diverged
```

38.7 Getting a Diff

```
$ git diff           # Diffs between working tree and stage
$ git diff HEAD^    # Diff from the previous commit to here
$ git diff HEAD^^   # Diff from the 2nd last commit to here
$ git diff HEAD~3 HEAD~2 # Diff from 3rd last to 2nd last commit
$ git diff CMMT     # Diff between CMMT and now
$ git diff CMMT1 CMMT2 # Diff between two commits (older first)

$ git diff CMMT1...CMMT2 # Diff between CMMT2 and the common
                       # ancestor of CMMT1 and CMMT2

$ git diff HEAD~3^!  # Diff between HEAD~3 and its parent
$ git diff -- FILE  # Run a diff just for a specific file
$ git diff HEAD^ -- FILE # Run a diff just for a specific file

$ git diff -U5      # Show 5 lines of context
$ git diff -w       # Ignore whitespace
$ git diff --name-only # Only show filenames of changed files
$ git diff --staged # Diffs between stage and repo
$ git diff difftool # Diffs using the configured diff tool
```

38.8 Branches

A local branch looks like `branchname`. A remote tracking branch looks like `remote/branchname`.

```
$ git switch BRANCH      # Switch to a branch
$ git switch --detach HASH # Detach HEAD to a commit
$ git switch -           # Switch back to previous commit
```

```
$ git switch --detach HEAD^ # Switch to previous commit
$ git switch --detach HEAD^^ # Switch to 2 commit ago
$ git switch --detach HEAD~3 # Switch to 3 commits ago
$ git switch --detach HEAD~99 # Switch to 99 commits ago
```

```
$ git switch main # Reattach HEAD to main
```

```
$ git branch -v # List all branches
$ git branch -va # List all including remote tracking branches
```

```
$ git switch -c BRANCH # Create and switch to BRANCH
$ git branch BRANCH # Create BRANCH at HEAD
$ git branch BRANCH1 BRANCH2 # Create BRANCH1 at BRANCH2
```

```
$ git branch -d BRANCH # Delete fully merged branch
$ git branch -D BRANCH # Force delete unmerged branch
```

Obsolete style (use `switch` if you can):

```
$ git checkout CMMT # Detach HEAD to a commit
$ git checkout HEAD^ # Detach HEAD to previous commit
$ git checkout HEAD~2 # Detach HEAD to second previous commit
```

38.9 Pulling and Pushing, and Fetching

```
$ git pull # Pull from remote and merge or rebase
$ git pull --ff-only # Only allow fast-forward merges
$ git pull --rebase # Force a rebase on pull
$ git pull --no-rebase # Force a merge on pull
```

```
$ git push # Push this branch to its remote

$ git push REMOTE BRANCH # Create remote tracking branch and
# push to remote

$ git push -u REMOTE BRANCH # Create remote tracking branch and
# push to remote, and use subsequent
# `git push` commands for this local
# branch

$ git push -u origin branch99 # Example

$ git push --tags # Push all tags to origin
$ git push REMOTE --tags # Push all tags to specific remote
$ git push REMOTE tag3.14 # Push single tag
```

```
$ git fetch          # Get data from remote but don't merge or rebase
$ git fetch REMOTE # Same, for a specific remote
```

38.10 Merging

```
$ git merge CMMT      # Merge commit or branch into HEAD
$ git merge --abort   # Rollback the current merge
$ git mergetool       # Run mergetool to resolve a conflict

$ git checkout --merged FILE # Unstage resolved files
```

In a conflict occurs, you can always `--abort`. Otherwise:

1. Fix the conflict.
2. Add the fixed files.
3. Commit to complete the merge.

38.11 Remotes

```
$ git remote -v          # List remotes
$ git remote set-url REMOTE URL # Change remote's URL
$ git remote add REMOTE URL # Add a new remote
$ git remote rename REMOTE1 REMOTE2 # Rename REMOTE1 to REMOTE2
$ git remote remove REMOTE # Delete REMOTE
```

38.12 Ignoring Files

Add a `.gitignore` file to your repo. It applies to this directory and all non-submodule subdirectories below it. Add descriptions of files to ignore to this file. Comments behind `#` are allowed. Blank lines are ignored.

Example `.gitignore`:

```
foo.aux      # Ignore specific file "foo.aux"
foo.*        # Ignore all files that start with "foo."
*.tmp       # Ignore all files that end with ".tmp"
frotz/      # Ignore all files in the "frotz" directory
foo[12].txt # Ignore "foo1.txt" and "foo2.txt"
foo?        # Ignore "foo" followed by any single character
frotz/bar   # Ignore file "bar" in directory "frotz"
*           # Ignore everything
```

Exceptions to earlier rules, also useful in `.gitignore` files in subdirectories to override rules from parent directories:

```
*.txt      # Ignore all text files
!keep.txt  # Except "keep.txt"
```

38.13 Rebasing

```
$ git rebase CMMT      # Rebase changes onto commit
$ git rebase -i CMMT   # Interactive rebase (squashing commits)
$ git rebase --continue # Continue processing from conflict
$ git rebase --skip     # Skip a conflicting commit
$ git rebase --abort    # Bail out of rebasing
```

```
$ git pull --rebase    # Force a rebase on pull
$ git pull --no-rebase # Force a merge on pull
```

38.14 Stashing

Stashes are stored on a stack.

```
$ git stash push      # Stash changed files
$ git stash           # Effectively the same as "push"
$ git stash FILE      # Stash a specific file
$ git stash pop       # Replay stashed files on working tree
$ git stash list      # List stashed files

$ git stash pop 'stash@{1}' # Pop stash at index 1
$ git stash pop --index 1   # Same thing
$ git stash drop 'stash@{1}' # Drop stash at index 1
$ git stash drop --index 1  # Same thing
```

38.15 Reverting

```
$ git revert CMMT      # Revert a specific commit
$ git revert -n CMMT   # Revert but don't commit (yet)

$ git revert CMMT1 CMMT2 # Revert multiple commits
$ git revert CMMT1^..CMMT2 # Revert a range (oldest first)

$ git revert --continue # Continue processing from conflict
$ git revert --skip     # Skip a conflicting commit
$ git revert --abort    # Bail out of reverting
```

38.16 Resetting

All resets move HEAD and the current checked out branch to the specified commit.

```
$ git reset --mixed CMMT # Set stage to CMMT, don't change WT
$ git reset CMMT         # Same as --mixed
$ git reset --soft CMMT  # Don't change stage or working tree
```

```
$ git reset --hard CMMT # Set stage and WT to CMMT
$ git reset -p CMMT     # Reset file in patch mode
```

Obsolete usage:

```
$ git reset FILE # Same as "git restore --staged FILE"
```

38.17 The Reflog

```
$ git reflog # Look at the reflog
```

...I admit this section could use a bit more information.

38.18 Cherry-pick

```
$ git cherry-pick CMMT # Cherry-pick a particular commit
```

38.19 Blame

```
$ git blame FILE # Who is responsible for each line
$ git blame --date=short FILE # Same, shorter date format
```

38.20 Submodules

```
$ git clone --recurse-submodules URL # Clone with submodules
$ git submodule update --recursive --init # If you cloned without

$ git submodule add URL # Add submodule
$ git add DIR # Add to repo
$ git pull --recurse-submodules # Pull including submodules

$ git submodule status # Submodule status
$ git ls-tree HEAD DIR # Show submod pinned commit
$ git submodule init # Set up bookkeeping
$ git submodule update # Bring in missing submods
$ git submodule update --recursive # Handle submods of submods
```

Deleting a submodule—do these in order. In this example, DIR is the name of the submodule directory.

```
$ git submodule deinit DIR
$ rm -rf .git/modules/DIR
$ git config -f .gitmodules --remove-section submodule.DIR
$ git add .gitmodules
$ git rm --cached DIR
```

```
$ git commit -m "remove DIR submodule"
```

38.21 Tags

```
$ git tag      # List tags  
$ git tag -l  # List tags
```

```
$ git tag TAG          # Create a tag on HEAD  
$ git tag TAG CMMT     # Create a tag on a specific commit  
$ git tag -a TAG       # Create an annotated tag  
$ git tag -a TAG CMMT  # On a specific commit  
$ git tag -a TAG -m "message" # Add a message to the tag
```

```
$ git push --tags      # Push all tags to origin  
$ git push REMOTE --tags # Push all tags to specific remote  
$ git push REMOTE tag3.14 # Push specific tag
```

```
$ git tag -d tagname      # Delete a tag locally  
$ git push REMOTE -d tagname # Delete a tag on a remote
```

38.22 Worktrees

```
$ git worktree list  # List worktrees  
  
$ git worktree add DIR CMMT          # Add worktree at CMMT  
$ git worktree add --detach DIR CMMT # Add, detach head at CMMT  
$ git worktree add DIR HASH          # Add, detach head at HASH  
  
$ git worktree remove DIR          # Remove worktree  
$ git worktree remove --force DIR  # Remove, lose uncommitted mods
```

Index

- .git directory, 8, 42
 - Preventing in home, 43
 - Removing, 43
- .gitignore file, 44–47, 186
 - Boilerplate, 47
 - Location, 46
 - Negated rules, 46
 - Wildcards, 46
 - With subdirectories, 45
- Add, 11, 183
- Alias, 133–135, 183
 - Creating, 133
 - Debugging, 135
 - Displaying, 134
 - Examples, 134
- Bare repo, 167
- Blame, 126–127, 188
 - Fancier output, 126–127
- Branch, 27–35, 185
 - Creating, 31–32
 - Deleting, 35
 - Deleting remote, 55–56
 - Deleting remote tracking, 55–56
 - Diff, *see* Diff, Between branches
 - Divergent, 36
 - Listing, 30–31
 - Listing remote tracking, 52–53
 - main, 27
 - Moving, 111
 - on GitHub, *see* GitHub, Branches
 - On remote, 51–52
 - Pushing to remote, 53
 - Remote tracking, 51–57
 - Set upstream, 53–54
 - Topic, 35
- Checkout, 25, 185
- Cherry-pick, 122–125, 188
 - Conflicts, 125
- Clone, 6–8, 167, 183
- Collaboration
 - Across branches, 72–76
- Commit, 5, 12, 183
 - Amending, 140–141, 183
 - Amending commit messages, 140–141
 - Amending files, 141
- Communication, 73
- Configuration, 7, 128–132, 181–183
 - Alias, *see* Alias
 - Autocorrect, 182
 - Color output, 182
 - Commonly-set variables, 130–131
 - Conditional, 132
 - Default branch, 7, 181
 - Delete, 130
 - Deprecated usage, 132
 - Difftool, 182
 - Editing directly, 131–132
 - Editor, 182
 - Get, 130
 - GPG signing key, 137–138
 - Listing, 129–130
 - Local, 129
 - Mergetool, 182
 - Name and email, 7, 136, 181
 - Newline translation, 182
 - Pull rebase behavior, 182
 - Set, 130
 - SSH identity, 137, 181
 - SSH signing key, 138–139
 - Unset, 130
- Detached HEAD, *see* HEAD, Detached
- Diff, 10, 61–66, 184
 - Additional context, 65
 - Between branches, 66
 - File names only, 65
 - Ignore whitespace, 65
 - Other branches, 63
 - Other commits, 63
 - Parent commit, 65
 - Specific files, 65
 - The stage, 62–63
 - Understanding the output, 61–62
- Difftool, 142–144
 - Configuration, 143
- Errors, 172–174
 - Branch name doesn't match, 173

- Detached HEAD, 172–173
 - No upstream branch, 174
- Exiting editors, 171
- Fast-forward, *see* Merge, Fast-forward
- Fetch, 29, 56, 57, 79, 98, 99, 109, 110, 155, 185
 - Pruning remote tracking branches, 55
- File States, 58–60
 - Modified, 58
 - Multiple, 60
 - Staged, 58
 - Unmodified, 58
 - Untracked, 58
- Fork, 92–99
 - Creating, 93
 - Process, 92
 - Syncing with Upstream, 94, 98–99
- `git add`, *see* Add
- `git add -p`, *see* Patch mode
- `git blame`, *see* Blame
- `git branch`, *see* Branch
- `git checkout`, *see* Checkout
- `git cherry-pick`, *see* Cherry-pick
- `git clone`, *see* Clone
- `git commit`, *see* Commit
- `git config`, *see* Configuration
- `git diff`, *see* Diff
- `git fetch`, *see* Fetch
- `git log`, *see* Log
- `git merge`, *see* Merge
- `git mv`, *see* Move
- `git pull`, *see* Pull
- `git push`, *see* Push
- `git push --set-upstream`, *see* Branch, Set upstream
- `git push -u`, *see* Branch, Set upstream
- `git rebase`, *see* Rebase
- `git reflog`, *see* Reflog
- `git remote`, *see* Remote
- `git rerere`, 83
- `git reset`, *see* Reset
- `git reset -p`, *see* Patch mode
- `git restore`, *see* Restore
- `git revert`, *see* Revert
- `git rm`, *see* Remove
- `git stash`, *see* Stash
- `git status`, *see* Status
- `git switch`, *see* Switch
- `git tag`, *see* Tag
- `git worktree`, *see* Worktree
- Gitea, 5
- GitHub, 5, 14–20
 - Account creation, 14
 - Adding collaborators, 19
 - Authentication, 15
 - Branches, 54
 - Cloning, 18
 - Cloning with GitHub CLI, 18
 - Cloning with SSH, 19
 - GitHub CLI setup, 15
 - Repo creation, 14
 - SSH setup, 16
- GitLab, 5
- HEAD, 22–25
 - Commits relative to, 26
 - Detached, 23, 24, 29–30, 164–165, 172–173
 - With branches, 29
- Identity, 136–139
- Ignoring files, *see* `.gitignore`
- Index, *see* Stage
- Log, 21–22, 184
- main, *see* Branch, main
- master, *see* Branch, master
- Merge, 28, 33–41, 186
 - Compared to rebasing, 77–78
 - Conflicts, 38–41
 - Fast-forward, 33–35
- Mergetool, 145–148
 - File backups, 148
 - With Vimdiff, 146–148
- Move, 67–68, 183
 - Reverting, 67
 - Unstaging, 67–68
- origin, *see* Remotes, origin
- origin/main, *see* Branch, Remote tracking
- Patch mode, 116–121
 - Add, 116–118
 - Reset, 118–121
- Playground, 166–170
 - Automating, 169–170
 - Cloning, 167
- Pull, 7, 185
 - Force rebase or merge, 29, 187
- Pull request
 - Creating, 95
 - Deleting, 97
 - Merging, 95–96
 - With branches, 96–97
- Pull requests, 92–99
- Pulling, 169
- Push, 6, 13, 19, 185
 - Branch to remote, 53–54

- Forced, 109–110
- Tags, 160
- Pushing, 168
- Rebase, 77–87, 187
 - And pulling, 79–80
 - Compared to merging, 77–78
 - Conflicts, 80–83, 86–87
 - Fixup, 86
 - Squashing commits, 83–86
 - When to use, 79
- Recursion, *see* Recursion
- Reference Material, 178–179
 - Free, 178
 - man pages, 178
 - Non-free, 179
- Reflog, 112–115, 188
 - Finding an orphan commit, 112–115
 - Selectors, 115
 - Uses, 112
- Remote, 48–50, 186
 - Adding, 49–50
 - Listing, 48
 - Multiple, 56–57
 - origin, 9, 48
 - Remote branches, 48
 - Setting the URL, 49
 - Sync with upstream, 50
 - upstream convention, 50
- Remove, 68–71, 183
 - Secrets, 70–71
 - Unremoving from earlier commits, 69–70
 - Unstaging, 68–69, 183
- Rename, *see* Move
- Reset, 104–111, 187
 - Files, 108
 - Hard, 107
 - Mixed, 107
 - Pushing to remote, 108–109
 - Soft, 105–106
 - To divergent branch, 107
- Revert, 100–103, 187
 - Conflicts, 101–102
 - Multiple commits, 102–103
- Shell scripts, 169
- Stage, 11
- Stash, 88–91, 187
 - Conflicts, 90–91
 - New files, 91
 - The stack, 89–90
- Status, 9, 10, 184
- Subdirectories, 42–43
 - Empty, 43
- Submodules, 149–158, 188–189
 - Creating, 150–152
 - Deleting, 157–158, 188
 - Getting latest, 154–155
 - Setting the commit, 152–154
 - Status, 155–156
 - Updating, 155
- Subprojects, 42
- Switch, 23, 26, 184–185
- Tag, 159–161, 189
 - Annotated, 160
 - Creating, 159–160
 - Deleting, 160–161
 - Lightweight, 159–160
 - Listing, 159
 - Pushing, 160
- Translations, 2
- Undelete, *see* Remove, Undelete
- Untracking files, 59
- Workflow
 - Basic, 5, 7–13
 - Dev branch, 74–76
 - File states, 59
 - One Branch, 73
 - One Branch per Dev, 73–74
- Worktree, 162–165, 189
 - Choosing location, 162
 - Creating, 163
 - Detached HEAD, 164–165
 - Listing, 164
 - main worktree, 162
 - Removing, 163–164